



**HAL**  
open science

# Crypto-Compression System for Secure Transfer of Medical Images

Jean-Claude Borie, William Puech, Michel Dumas

► **To cite this version:**

Jean-Claude Borie, William Puech, Michel Dumas. Crypto-Compression System for Secure Transfer of Medical Images. MEDSIP: Medical Image and Signal Processing, Sep 2004, Malte, France. pp.327-331. lirmm-00108807

**HAL Id: lirmm-00108807**

**<https://hal-lirmm.ccsd.cnrs.fr/lirmm-00108807v1>**

Submitted on 23 Oct 2006

**HAL** is a multi-disciplinary open access archive for the deposit and dissemination of scientific research documents, whether they are published or not. The documents may come from teaching and research institutions in France or abroad, or from public or private research centers.

L'archive ouverte pluridisciplinaire **HAL**, est destinée au dépôt et à la diffusion de documents scientifiques de niveau recherche, publiés ou non, émanant des établissements d'enseignement et de recherche français ou étrangers, des laboratoires publics ou privés.

# CRYPTO-COMPRESSSION SYSTEM FOR SECURE TRANSFER OF MEDICAL IMAGES

Jean-Claude Borie<sup>1</sup>, William Puech<sup>2</sup> and Michel Dumas<sup>1</sup>

<sup>1</sup>CEM2 Laboratory , STINIM , UMR 5507 CNRS, University of Montpellier II, Pl. Gabriel Péri, 30021 Nîmes Cedex 1, France

<sup>2</sup> LIRMM,UMR CNRS-UM2 5506, University de Montpellier II,161 street Ada, 34392 Montpellier Cedex 05, France.

borie@univ-montp2.fr, william.puech@lirmm.fr, dumas@univ-montp2.fr

## Abstract:

In this paper, we discuss the secure of transferring of medical images. We propose two cryptosystems, the first one is a very fast algorithm by block, the TEA (Tiny Encryption Algorithm) and the second is a stream cipher based on Vigenere's ciphering. We show differences existing between them, especially concerning the combination of the image encryption and the compression. Results applied to medical images are given to illustrate the two methods.

**keywords** : secure transfer, medical, images, block cipher, stream cipher, crypto-compression.

## INTRODUCTION

Ciphering of medical images is actually an important issue. One essential difference between text data and image data is that the size of image data is much larger than the text data. The time is a factor very important for the image encryption. We find it at two levels, one is the time to encrypt, the other is the time to transfer images. To minimize it, the first step is to choose a robust, rapid and easy method to implement cryptosystem. An other important criteria concerns the method of compression, it will decrease the size of images without loss of image quality. In our study we have found some articles on crypto-compression: one of them talk about image coding for mobile using tree structures [1], the second on compression and encryption of binary and gray-scale images using schemes based on SCAN [2]. Other articles dealing with medical imagery in particular in [3] and in [4] a partial encryption technique based on AES the new standard is proposed.

This paper is organized as follows. In Section 2, we briefly present TEA and stream cipher cryptosystems. In Section 3, we propose a crypto-compression process, in the articular case for echography images. Finally some conclusions are given in Section 4.

## ENCRYPTION ALGORITHMS

In previous papers [5,6], we have studied a public key cryptosystem to encrypt image pixel by pixel, with the RSA algorithm. But, if we take blocks of several pixels, the time of ciphering is too long. We have considered other systems with a secret key. The algorithm DES and RSA require much time to encrypt images and it is not

also very interesting. Among several systems, we have retained two of them: the TEA and the stream cipher method.

## Tiny Encryption Algorithm

TEA is a short algorithm [7] which uses Feistel block cipher with a 128-bit key  $K$  and 64-bit message blocks. It uses arithmetic and XOR operations rather than substitution (S-Box) and permutation. The number of rounds is variable, for a good security 32 rounds are necessary, but authors advise that 64 rounds are better. A cycle of TEA applied to the block  $y_i, z_i$  consists of:

$$\begin{aligned} y_{i+1} &= y_i + f(z_i, s, k[0, 1]), \\ z_{i+1} &= z_i + f(y_{i+1}, s, k[2, 3]), \end{aligned} \quad (1)$$

where  $k[0], k[1], k[2]$  and  $k[3]$  are 32-bit subkeys obtained from  $K$ .

Initially  $s = 0$  and in each round it is incremented by a fixed constant  $\delta = [(\sqrt{5} - 1)2^{31}]$ .

## A stream cipher method

This cryptosystem was proposed by W.Puech and *al* [8]. It constitutes a variant of Vigenere's cipher, illustrated Figure 1.

If  $p(n)$  is a pixel of the original image,  $p'(n)$  the ciphered

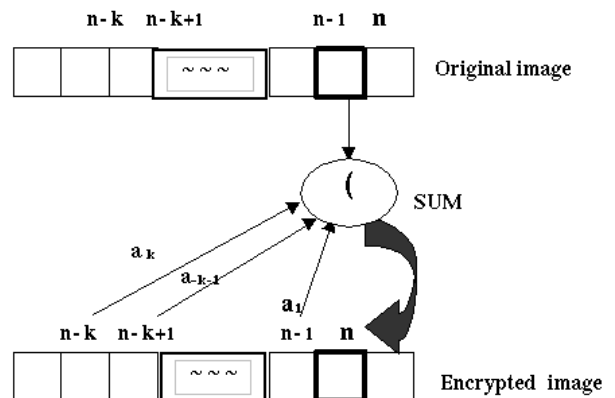


Fig. 1: Stream cipher method.

pixel is according to the next equation:

$$p'(n) = p(n) + \alpha(1)p'(n-1) + \dots + \alpha(k)p'(n-k), \quad (2)$$

where  $n \in [k, N]$  with  $k \in [1, n]$  and  $N$  the number of pixels.

The coefficients  $\alpha(k)$  are generated with the keystream. The equation (2) can be written:

$$p'(n) = p(n) + \sum_{i=0}^{i=k} \alpha(i) \cdot p'(n-i), \quad (3)$$

where  $k$  is the order of recurrence corresponding to the length of the chosen key.

The particularity of the method resides in the fact that the encryption of each pixel depends on three elements, the pixel in clear, the keystream, and the  $k$  precedent pixels in the image. Moreover, our encryption system requires the introduction of  $k$  virtual pixels to encrypt the  $k$  first pixels. The  $\alpha_i$  coefficients have been coded on two bits, we have chosen the following values (Table 1):

During the binary lecture of the keystream, to the binary

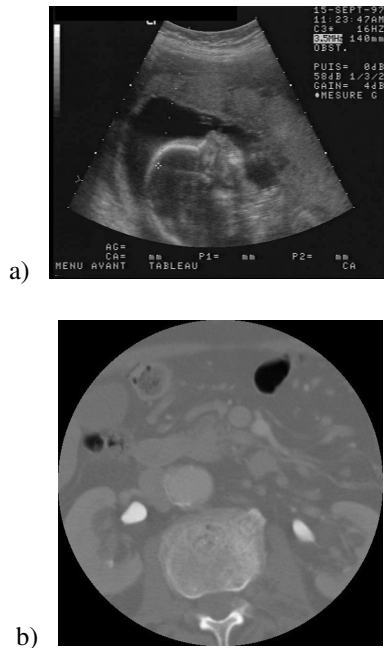
| two bits value | 00 | 01 | 10 | 11    |
|----------------|----|----|----|-------|
| $\alpha_i$     | 0  | +1 | -1 | +/- 2 |

**Table 1:**  $\alpha_i$  coefficients

value 11 is associated alternately the number +2 or -2. In this case, the effective length of the key to use is  $2 \cdot k$  bits.

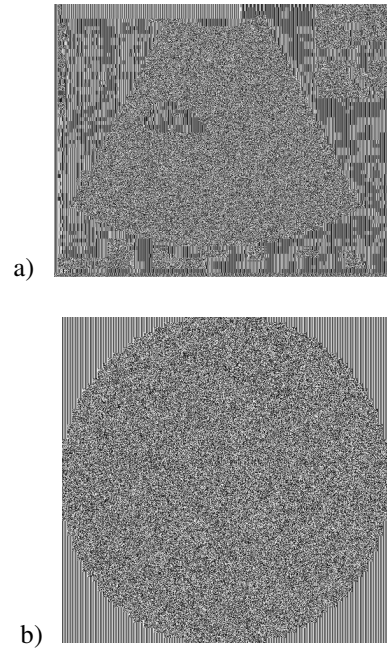
### Application on medical images

To illustrate the proposed methods, we have chosen two images, one echography (405 KB-Figure 2.a) and the other obtained by scanner (256 KB- Figure 2.b).



**Fig. 2:** Original image a) echography b) scanner.

**TEA encryption :** The Tiny Encryption Algorithm is fast to encrypt and decrypt medical images, around one second for echography using a pentium III. But the nature of encryption clearly shows blocks encryption. Besides,



**Fig. 3:** TEA ciphering a) echography b) scanner.

Figures 3.a and b allow to guess the nature of images. We have observed that with a 3D reconstruction of the aorta image (256KB) from 2D image sections obtained by scanner, the encryption is also not very good (Figures 4.a and 4.b).

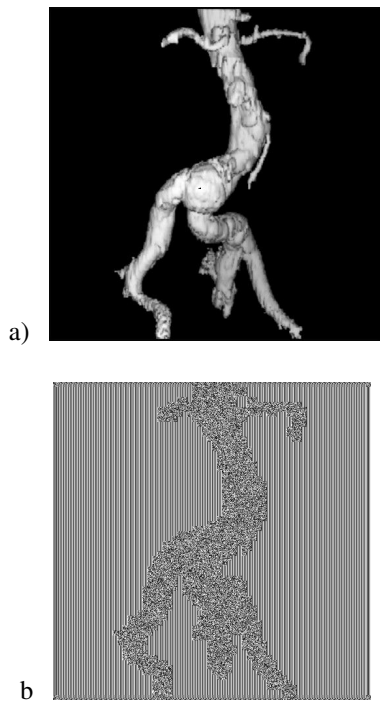
**Stream cipher** We have chosen a 128-bit keystream which generates 64 virtual pixels and 64  $\alpha_i$  coefficients with  $-2 \leq \alpha_i \leq +2$ . On these images (Figures 5.a and 5.b), the advantage of stream cipher appears clearly, one has no indication on used cryptosystem as well as on the nature of the image, even for the 3D image of the aorta.

### COMPRESSION

#### Problem on image compression.

The transmission of numerical images often needs an important number of bits. This number is again more consequent when it concerns medical images. If we want to transmit these images by network, reducing the image size is important. The goal of the compression is to decrease this initial weight. This reduction strongly depends of the used compression method, as well as of the intrinsic nature of the image. Therefore the problem is the following:

1. To compress without lossy, but with low factor compression. If you want to transmit only one image, it is satisfactory. But in the medical area,



**Fig. 4:** TEA ciphering c) aorta 3D d) encrypted image.

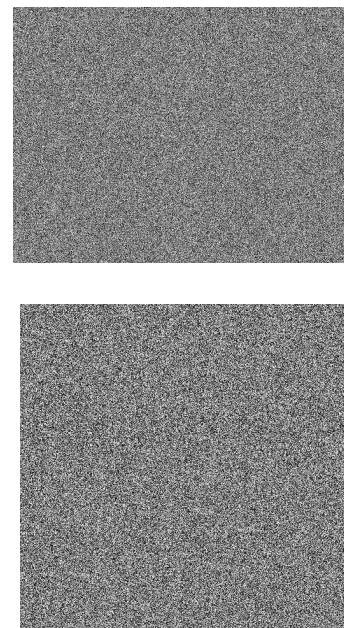
these are often sequences that the doctor waits to emit a diagnostic.

2. To compress with losses with the risk to lose information .

The question that puts then is what are the relevant informations to preserve and those that can be neglected without altering the quality of the diagnosis or the analysis. The human visual system is one of the means of appreciation, although subjective and being able to vary from an individual to an other. However, this system is still important to judge the possible causes of degradation and the quality of the compression.

### Our method

We are going to see that encryption and compression constitute a pair that is difficultly reconcilable, one has tendency to increase the weight of the file, the other to decrease the image quality. The solution that we have proposed is to join these two methods in one: the crypto-compression. This compromise appears to be enough satisfactory, on one hand the compression is without loss with a rate oscillating between 1.5 and 4 according to cases, on the other hand an unique program suffices to undertake two operations. These values are close to those obtained by others methods. For example, LZ77 or LZ78 are the names for the two lossless data compression algorithms published by A.Lempel and J.Jacob [9, 10]. They are both dictionary coders. Later in

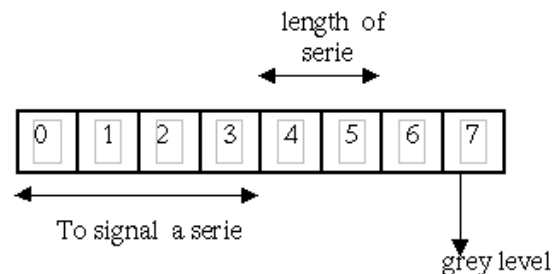


**Fig. 5:** Stream cipher a) Echography b) scanner.

1984, LZ77( LZ78) was improved by T. Welch, resultant in LZW [11]. We have used also the new lossless format JPEG2000 which has replaced the old JPEG [12].

The proposed method is analogous to Run Length Coding, and it is usable for images comprising homogeneous areas as medical images, especially in the 3D image of the aorta where great black zones appear. These images possess often very numerous redundancies that are the basis of the proposed method of compression. We consider a block of  $n$  consecutive pixels having the same level of gray. If the block is heterogeneous it is encrypted without special treatment. If the block of  $n$  pixels is homogeneous, we read the next serie and so on until the next heterogeneous block. All identical blocks are coded in the same manner.

To signal the redundancy of this serie we use an eight



**Fig. 6:** Crypto-compression method.

block bytes The distribution of the eight bytes is the following (Figure.6):

- the four bytes of strong weight serve to signal that there is a serie of  $n$  identical pixels;
- the two next bytes indicate the length of the continua-

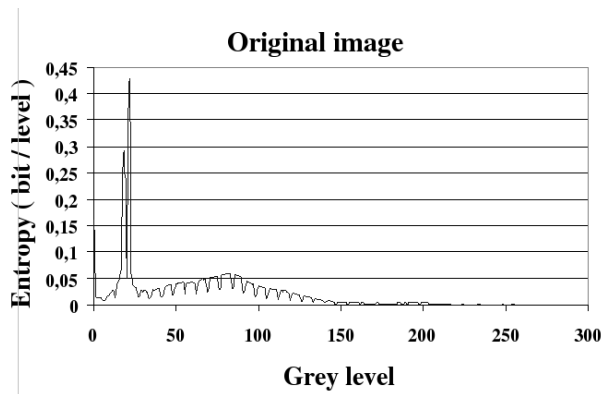
tion;  
 - the seventh byte serves to define the serie;  
 - finally the weak weight byte indicates the value of grey level.

## Results

To estimate the quality of the process of crypto-compression we have studied the evolution of the entropy:

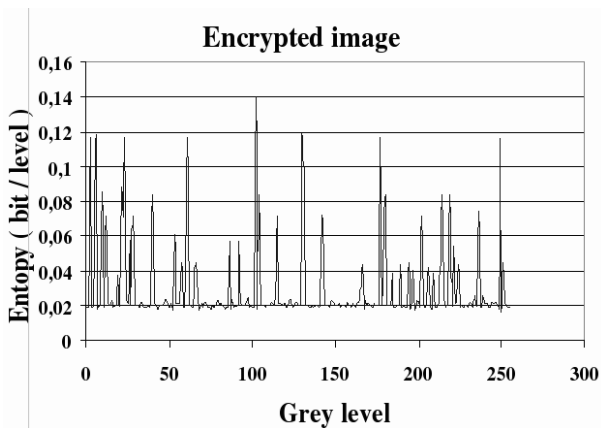
$$H = - \sum_{i=0}^{2^R-1} n_i \cdot \log_2 p(n_i), \quad (4)$$

where  $n_i$  is the value of grey level,  $p(n_i)$  the probability to find this grey level and  $R$  the number of bits per pixel. Entropy allows to have an idea of the redistribution of pixels and the number necessary for transmission by network. The entropy of the echography (Figure 7) shows a

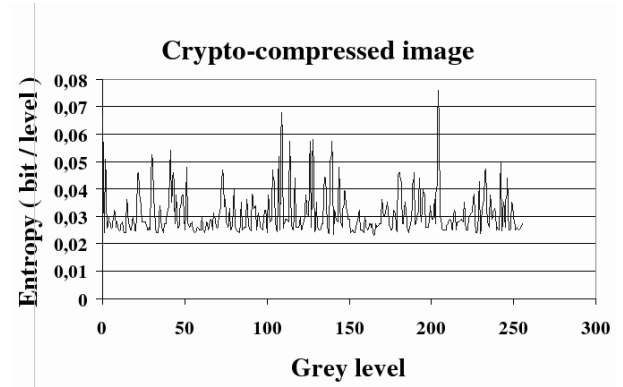


**Fig. 7:** Echography: entropy of original image- Figure 2.a.

peak which corresponds about 38.3% of pixels having an initial grey level of 0. The Figure 8 shows the effect of encryption by blocks of 64 bits with eight modes dominants. Figure 9 indicates that pixels are redistributed in almost homogeneous way with an average of  $0.031 \text{ bit/pixel}$ . The entropy of the echography (Figure 7) shows a peak



**Fig. 8:** Echography: entropy of the encrypted-image.



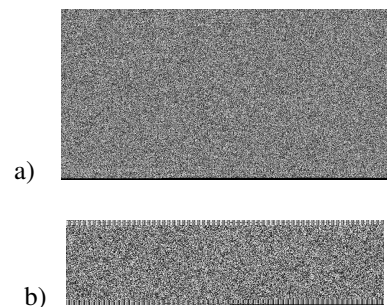
**Fig. 9:** echography :entropy crypto-compressed image.

which corresponds about 38.3% of the pixels having an initial grey level of 0. The Figure 8 shows the effect of encryption by blocks of 64 bits with eight modes dominants. Figure 9 indicates that pixels are redistributed in almost homogeneous way with an average about  $0.031 \text{ bit/pixel}$ . We observe (Table 2) that the entropy of encrypted im-

|                                  | <i>Entropy<br/>(bits/pixel)</i> |
|----------------------------------|---------------------------------|
| <i>Original image</i>            | 5.9                             |
| <i>Encrypted image</i>           | 7.5                             |
| <i>Crypto - compressed image</i> | 7.9                             |

**Table 2:** Echography:entropy variations.

age is very high and the entropy of crypto-compressed one is better (near eight bits/pixel). But our method allows to realize two operations in the same time and to reduce the size of the file. The Figure 10.a represents the image of echography after crypto-compression, its size is  $320 \text{ KB}$  with a rate of compression of 1.3. The image of aorta Figure 10.b having homogeneous blocks more numerous, the size is reduced from  $256 \text{ KB}$  to  $68 \text{ KB}$  for a rate of compression of 3.76.



**Fig. 10:** a) echography b) 3D image aorta.

## CONCLUSION

In this paper, we have presented methods to encrypt images for a secure transfer purpose. We have shown

that the quality of the encryption depends on the chosen crypto-system.

Encryption increases the entropy of the image and thus the number of bits necessary by pixel. To transfer medical images without losses we think that crypto-compression seems to be an interesting solution with a rate varying between 1.3 and 3.8. The crypto-compression is adapted to the encryption by blocks as TEA but it is not possible with stream-ciphers.

## REFERENCES

- [1] Xiaobo Li, Jason Knipe, Howaed Cheng, *Image compression and encryption using tree structures*, Pattern Recognition Letters (1997) pages 1253-1259.
- [2] S.S.Maniccam, N.G.Bourbakis, *Lossless image compression and encryption using SCAN*, Pattern Recognition 34 (2001) pages 1229-1245.
- [3] F.Cao, H.K.Huang, X.Q.Zhou, *Medical image security in a HIPAA mandated PACS environment*, Computerized Medical Imaging and Graphics 27 (2003) pages 185-196.
- [4] R.Norcen, M.Podesser, A.Pommer, H.P.Schmidt, A.Uhl, *Confidential storage and transmission of medical image data*, Computers in Biology and Medicine 33 (2003) pages 277-292.
- [5] J.C.Borie, W.Puech, M.Dumas, *Encrypted Medical Images for Secure Transfer*, International Conference on Diagnostic Imaging and Analysis ICDIA 2002, Shanghai, P.R China August 18-20 pages 250-255.
- [6] J.C.Borie, W.Puech, M.Dumas, *Encrypted images for Secure transfer with RSA algorithm*, International Conference, COMMUNICATIONS 2002 proceedings, "Politecnica" University of Bucharest and IEEE romanian section, Romania, 5-7 december 2002.
- [7] <http://www.ftp.cl.cam.ac.uk/ftp/papers/djw-rmn/djw-rmn-tea.html>  
TEA, a Tiny Encryption Algorithm, D.Wheeler, R.Needham, Computer Laboratory Cambridge University UK November 1994.
- [8] W.Puech, J.J.Charre and M.Dumas. *Transfert sécurisé d'images par chiffrement de Vigenère*. In NîmesTic 2001 .La relation Homme-Système: Complexe, Nîmes, France ,pages 167-171, dec 2001.
- [9] J.Ziv, A.Lempel, *A Universal Algorithm for Sequential Data Compression*, IEEE trans.Inform.Rheory, 1977 vol.23, no.3, pp 337-343.
- [10] J.Ziv, A.Lempel, *Compression of Individual Sequences via Variable-rate Coding*, IEEE trans.Inform.Rheory, 1978 vol.24, no.5, pp 530-536.
- [11] T.A.Welch, *A technique for High-Performance Data Compression*, Computer, 1984, vol.17, no.6, pp 8-19.
- [12] <http://www.jpeg.org/jpeg2000>.