



HAL
open science

Mechanical Design of a New Pneumatically Driven Underactuated Hand

Vincent Begoc, Sébastien Krut, Etienne Dombre, Claude Durand, François Pierrot

► **To cite this version:**

Vincent Begoc, Sébastien Krut, Etienne Dombre, Claude Durand, François Pierrot. Mechanical Design of a New Pneumatically Driven Underactuated Hand. ICRA 2007 - International Conference on Robotics and Automation, Apr 2007, Roma, Italy. pp.927-933, 10.1109/ROBOT.2007.363104 . lirmm-00189382

HAL Id: lirmm-00189382

<https://hal-lirmm.ccsd.cnrs.fr/lirmm-00189382>

Submitted on 22 Sep 2022

HAL is a multi-disciplinary open access archive for the deposit and dissemination of scientific research documents, whether they are published or not. The documents may come from teaching and research institutions in France or abroad, or from public or private research centers.

L'archive ouverte pluridisciplinaire **HAL**, est destinée au dépôt et à la diffusion de documents scientifiques de niveau recherche, publiés ou non, émanant des établissements d'enseignement et de recherche français ou étrangers, des laboratoires publics ou privés.

Mechanical design of a new pneumatically driven underactuated hand

V. Bégoc, S. Krut, E. Dombre, C. Durand and F. Pierrot

Abstract—This paper presents a new pneumatically driven underactuated hand with two fingers and 3 phalanxes per finger. Two evidences have led the design of this hand. Firstly, the use of pneumatic energy facilitates the underactuation of the hand, indeed a single T-connector suffices to share out one input among two outputs. Secondly, non-backdrivable mechanisms have to be used in the transmission of phalanx's motion so that the hand is capable of producing form-closed grasps. This latter design principle is justified using a newly developed method that permits to study the form-closure property of a grasp exerted by an underactuated hand. Moreover, the intriguing ejection phenomenon is avoided thanks to non-backdrivable mechanisms that prohibit any backward motion of phalanxes when correctly positioned. An original mechanism called the “pneumatic parallelogram” is described, it enables the hand to perform fine pinch grasps. Finally, the optimal design of both fingers is addressed with respect to the force-isotropy of the finger and the positiveness of phalanx forces.

I. INTRODUCTION

ROBOTIC hands can be classified in two major fields depending on whether their application requires manipulation or grasping capabilities. The first field has led to dexterous hands with several actuators and sensors. Pioneer designs include the Utah/MIT hand [1], the Stanford/JPL hand [2], the Belgrade/USC hand [3], the DLR hands [4]. In the meantime, significant progress have been made in the design of hands with simple mechanical and control architectures, while keeping versatile grasping capabilities. This could be accomplished using underactuation as a strategy to reduce the number of actuators while preserving the capability of the hand to adapt its shape to the grasped object. Good examples of such an approach are the Barrett Hand [5], the RTR II Hand [6], the SARAH and MARS Hands [7].

The hand we developed at the LIRMM is made up of two fingers and three phalanxes per finger (Fig. 1). Like the latter examples, underactuation has been used to ensure the shape adaptation of the hand to the grasped object. Indeed, a single controlled source of pressured air is distributed

among fingers and phalanxes, thus performing the closing process of the whole hand. In section II, this new kind of underactuation is compared with others existing using the classification proposed in [8]. As already seen on the Barrett Hand and the Sarah Hand, non-backdrivable mechanisms have been introduced in the transmission of motion of phalanxes. In our case, this is justified in section III, using a newly developed method [9] that proved the relevance of non-backdrivability in the capability of an underactuated hand to produce form-closed grasps. It is briefly recalled that form-closure is related to the capability of a grasp to immobilize an object. In section IV, more details are given on the pneumatic control of the hand and particularly on the so-called “pneumatic parallelogram”. This original pneumatic mechanism forces the distal phalanxes to remain perpendicular to the palm of the hand, permitting the hand to produce fine pinch grasps. Finally, the optimal kinematic design of fingers is addressed with respect to the positiveness of phalanx forces and the force-isotropy of the finger.

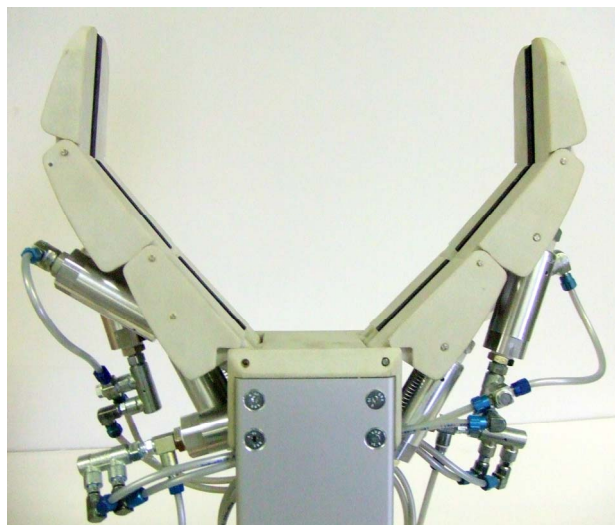

Fig. 1: Picture of the pneumatically driven underactuated hand.

II. UNDERACTUATION

A hand is said to be underactuated when it has fewer actuators than configuration variables [10], i.e. independent parameters able to characterize all feasible motions of the mechanism.

According to this definition, the proposed hand in this

S. Krut, E. Dombre and F. Pierrot are with the department of robotics, LIRMM, 161 rue Ada, 34392 Montpellier cedex 5, FRANCE (email: <krut, dombre, pierrot>@lirmm.fr).

C. Durand is with B+ Development, 1 traverse de la Penne, 13821 La Penne sur Huveaune FRANCE (email: c.durand@bplus-dev.fr).

V. Bégoc is with both the LIRMM and B+Development (email: begoc@lirmm.fr).

paper named TWIX is highly underactuated, since it has six configuration variables, one per phalanx and a single actuator. Indeed, each phalanx is moved by an air cylinder and all cylinders are connected to the same source of pressured air.

The author in [8] proposes to classify underactuation mechanisms into three different categories:

- Differential mechanisms: they can rely on classical technologies with pinions or be made of specific arrangements of linkages [7] or pulleys and cables [11].
- Compliant mechanisms: non-rigid bodies are used, such as in the “adaptive grasp mechanism” proposed in [6].
- Triggered mechanisms: once the torque exceeds a certain value, the joint locks. On the Barrett Hand, the transmission disengages and an irreversible mechanism prohibits backdrivability of the joint [5].

In accordance with this categorization, the TWIX Hand involves two strategies to achieve underactuation. Indeed, the multiple outputs pneumatic distributor (Fig. 2) is a differential mechanism since the following characteristic relation can be written:

$$\frac{F_a}{S_a} = \frac{F_1}{S_1} = \dots = \frac{F_n}{S_n}, \quad (1)$$

where F_a and F_i are resp. the input force and the i^{th} output force. S_a and S_i are the section areas of resp. the input pipe and the i^{th} output pipe. Secondly, as described later in this paper, the closing sequence of the hand is composed of two different phases. During the first phase, distal phalanxes remain perpendicular to the palm so that the hand is capable of producing fine pinch grasps. Once the fingers encounter an object, the pressured air is distributed among all cylinders and each phalanx is then powered. This results in whether an enveloping grasp or a fine pinch grasp, depending on the position, shape and size of the object. Thus, the TWIX hand could be labeled a triggered differential mechanism.

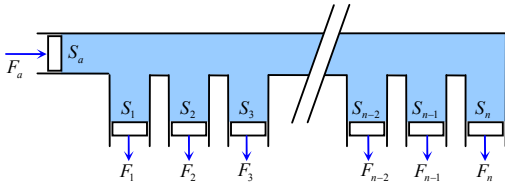

Fig. 2: A multiple outputs pneumatic distributor.

III. FORM-CLOSURE CAPABILITY OF UNDERACTUATED HANDS

The original definition of form-closure is based on the assumption that phalanxes are fixed in space. Hence, it is not adapted to study a grasp exerted by an underactuated hand, since in this case, the position of each phalanx can not be controlled independently. Thus, the condition of non-interpenetration of phalanxes with the object is reformulated. An extended definition of 1st order form-closure is proposed that considers all kinematic constraints of the system, namely contact constraints and constraints

imposed by non-backdrivable mechanisms. This permits to conclude on the minimum number of non-backdrivable mechanisms required to perform 1st form-closed grasps [9].

A. Original definition of form-closure

A set of contact constraints is defined 1st order form-closed iff, for all object motions $\dot{\mathbf{u}} \in \mathbb{R}^d$, at least one contact constraint is violated. [12]

where d is the dimension of the object’s configuration space, generally 3 for planar motions and 6 for spatial motions. The term “contact constraint” simply relates the fact that each part of the gripper that is in contact with the object, can’t penetrate it, when assuming that bodies are rigid.

As stated in [12], in many cases it is sufficient to study the first-order approximation of contact inequalities that can be written as following:

$$\mathbf{d}\mathbf{y}^o = \mathbf{P}\mathbf{d}\mathbf{u} \geq \mathbf{0}, \quad (2)$$

where $\mathbf{d}\mathbf{u}$ is an infinitesimal displacement of the object and $\mathbf{d}\mathbf{y}^o$ is the vector that contains infinitesimal displacements of contact points attached to the object along the normal of the phalanx. \mathbf{P} is the projection matrix

$$\mathbf{P} = \mathbf{N}^T \mathbf{G}^T, \quad (3)$$

where \mathbf{G} is the so-called grasp matrix

$$\mathbf{G} = \begin{bmatrix} \mathbf{I}_3 & \dots & \mathbf{I}_3 \\ \mathbf{C}(\mathbf{x}_1) & \dots & \mathbf{C}(\mathbf{x}_c) \end{bmatrix}, \quad (4)$$

$\mathbf{C}(\mathbf{x}_i)$ is the cross product matrix for vector \mathbf{x}_i which denotes the position of the i^{th} contact point in the hand reference frame. $\mathbf{N} = \text{diag}(\mathbf{n}_1, \dots, \mathbf{n}_c)$, where \mathbf{n}_i is the unit vector at the i^{th} contact point, normal to the phalanx and pointing into the object, c is the total number of contact points.

It follows therefrom the next definition:

Assuming that phalanxes are fixed, a grasp is said to be 1st order form-closed iff for any motion $\mathbf{d}\mathbf{u}$ of the object, at least one contact constraint is violated

$$\forall \mathbf{d}\mathbf{u} \in \mathbb{R}^{3d}, \exists i \in \{1, \dots, c\}, \text{ such that } \mathbf{d}y_i^o < 0, \quad (5)$$

B. Extension of form-closure for underactuated hands

In the previous original definition, phalanxes are supposed to be fixed relatively to the hand’s base frame. This hypothesis is false when considering an underactuated hand since the position of each phalanx can not be controlled independently. Based on this observation, the condition of non-interpenetration of phalanxes with the object is reformulated

$$\mathbf{d}\mathbf{y}^o - \mathbf{d}\mathbf{y}^f = \mathbf{S}\mathbf{P}\mathbf{d}\mathbf{u} - \mathbf{J}_H \mathbf{d}\boldsymbol{\theta} \geq \mathbf{0}, \quad (6)$$

where $\mathbf{d}y_i^f$ (resp. $\mathbf{d}y_i^o$) is an infinitesimal displacement of the contact point attached to the i^{th} phalanx (resp. to the object) along the normal \mathbf{n}_i . $\mathbf{d}\boldsymbol{\theta}$ is the vector of infinitesimal variation of phalanx joint coordinates. \mathbf{J}_H is the jacobian matrix of the hand and can be computed using the general approach given in [13]. \mathbf{S} is a diagonal matrix,

with $s_{ii} = 1$ if the i^{th} phalanx is in contact with the object, otherwise $s_{ii} = 0$. This selection matrix permits to consider cases where not all the phalanxes are in contact with the object.

A new definition is thus proposed that takes into account not only the contact constraints but also the constraints that are imposed by non-backdrivable mechanisms used in the transmission of phalanx's motion.

$$\forall \begin{bmatrix} \mathbf{d}\mathbf{u} \\ \mathbf{d}\boldsymbol{\theta} \end{bmatrix} \in \mathbb{R}^{*p+d}, \exists j \in \{1, \dots, c+k\}, \text{ such that } d\tilde{q}_j < 0, \quad (7)$$

where $\mathbf{d}\tilde{\mathbf{q}}$ is the vector that contains all unilateral constraints of the problem. This vector is built so that each component $d\tilde{q}_i$ has to be positive or null otherwise it is violated. k is the number of non-backdrivable mechanisms, c the number of contact points and p the number of phalanxes.

$$\mathbf{d}\tilde{\mathbf{q}} = \mathbf{Q} \begin{bmatrix} \mathbf{d}\mathbf{u} \\ \mathbf{d}\boldsymbol{\theta} \end{bmatrix} \text{ with } \mathbf{Q} = \begin{bmatrix} \mathbf{S}\mathbf{P} & -\mathbf{J}_H \\ \mathbf{0} & \mathbf{K} \end{bmatrix}, \quad (8)$$

where \mathbf{K} is the matrix that relates infinitesimal variations of phalanx joint coordinates $\mathbf{d}\boldsymbol{\theta}$ to infinitesimal displacements of non-backdrivable parameters $\mathbf{d}\mathbf{q}$.

When considering that the palm is contacting the object, a new contact constraint is added to the vector $\mathbf{d}\tilde{\mathbf{q}}$

$$\mathbf{d}\tilde{\mathbf{q}} = \begin{bmatrix} \mathbf{S}\mathbf{P} & -\mathbf{J}_H \\ \mathbf{0} & \mathbf{K} \\ \mathbf{n}_p^T [\mathbf{I}_3 \quad \mathbf{C}(\mathbf{x}_p)] & \mathbf{0} \end{bmatrix} \begin{bmatrix} \mathbf{d}\mathbf{u} \\ \mathbf{d}\boldsymbol{\theta} \end{bmatrix}, \quad (9)$$

where \mathbf{n}_p is the unit vector normal to the palm and \mathbf{x}_p denotes the position of the contact point in the hand reference frame.

Since the mathematical formalism used in (7) is similar to the one used in the original 1st order form-closure condition (5), theoretical results that have been demonstrated for the original form-closure can be extended to our case. Reuleaux [14] and Somov [15] proved that at least $d+1$ contact constraints are required for 1st order form-closure. In our case, at least $p+d+1$ unilateral constraints are needed to achieve 1st order form-closure

$$\tilde{k} \geq p+d+1, \quad (10)$$

where $\tilde{k} = c+k$ is the total number of unilateral constraints. Finally, the minimal number of non-backdrivable mechanisms needed for a hand to be capable of producing 1st order form-closed grasps is

$$k \geq p+d+1-c, \quad (11)$$

Considering a planar case ($d = 3$), the TWIX hand has to use at least four non-backdrivable mechanisms in order to be form-closure capable, assuming that all six phalanxes are contacting the object.

IV. DESIGN PRINCIPLES

In this section more details are given on the pneumatic control and the mechanical design of the hand. Non-return

valves are used according to (11) in order to make the hand form-closure capable. Moreover, it suppresses the ejection phenomenon, since any backward motion of phalanxes is prohibited. An original mechanism called the pneumatic parallelogram is then described. This mechanism constraints the distal phalanxes to remain perpendicular to the palm until the finger encounters an object. This allows the hand to perform fine pinch grasps, namely when only the distal phalanxes are contacting the object. Finally, kinematic parameters of the hand are optimised with respect to two criteria: the positiveness and the isotropy of phalanx forces.

A. Pneumatic control of the hand

The following pneumatic components have been used in the design of the hand (Fig. 3):

- V_{ij} : Frictionless diaphragm air cylinders (MM-2 – Controlair Inc.),
- NRV_{ij} : Air piloted, non-return valve (HGL - Festo),
- MV : manual monostable 5/3 valve (Camozzi),
- LPV_i : low pressure piloted pneumatic valve, monostable 5/2 (Bosch Rexroth),
- PV_i : pneumatic monostable 5/3 valve (Bosch Rexroth),
- $PVNC_i$: pneumatic monostable 3/2 normally closed valve (Bosch Rexroth).

The pneumatic control of the hand is voluntarily very simple, such that the closing and opening process is manually controlled with a single trigger. The closing sequence of each finger is composed of two successive phases. During phase 1, distal phalanxes remain perpendicular to the palm of the hand, in order to allow the hand to perform fine pinch grasps. Phase 2 follows phase 1 as soon as the finger encounters an object. Indeed, when the pressure in cylinder V_{i1} exceeds a given value, the pneumatic valve LPV_1 commutes and all cylinders are then powered. The resulting grasp is whether a fine pinch or an enveloping grasp depending on the size, shape and position of the object.

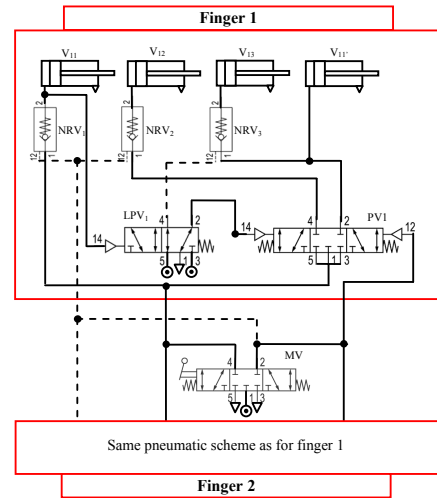

Fig. 3: Pneumatic scheme of the hand.

1) Phase 1: a pneumatic parallelogram for fine pinch

In the SARAH hand [7], distal phalanxes remain perpendicular to the palm of the hand thanks to a double parallelogram mechanism. This permits to produce fine pinch grasps. In our case this is accomplished thanks to an original pneumatic mechanism called the “pneumatic parallelogram” depicted on Fig. 4.

In order to simplify the notations, expressions are given now for a unique finger.

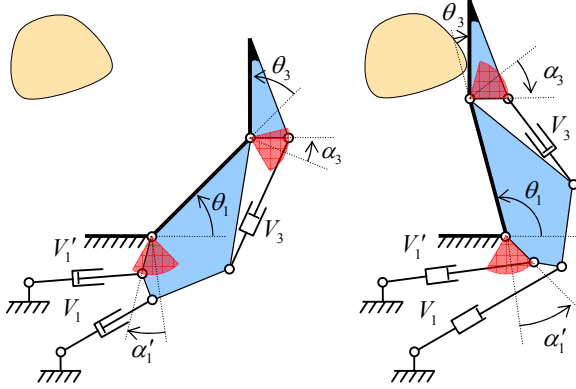

Fig. 4: Closing sequence – phase 1: the pneumatic parallelogram. The interdistal phalanx is not represented for the sake of clarity since $\theta_2 = 0$ during phase 1.

During Phase 1, only cylinder V_1 is powered. Cylinders V_3 and V_1' are connected to the same isolated chamber. Since they have the same piston diameters, this results in:

$$ds_1' = -ds_3, \quad (12)$$

where s_j is the stroke of cylinder V_j . Cylinders have been chosen with minimal friction so that minor error is introduced in (12) due to the compressibility of air.

Fig. 5 describes the correct position of cylinders V_3 and V_1' so that the relation (12) implies $d\theta_1 = -d\theta_3$, i.e. the piston rod has to be perpendicular to axis Δ_j in both extreme positions of the angular range of the distal phalanx. θ_j is the angular position of the j^{th} phalanx. Δ_j is the position of the lever arm of the j^{th} phalanx when half of its angular range has been covered. The following relation is obtained assuming that $s_j \gg c_j$:

$$d\theta_j = d\alpha_j = \frac{ds_j}{c_j \cos \alpha_j}, \quad (13)$$

where c_j is the length of the lever arm and α_j the angle between the lever arm and the axis Δ_j .

In a symmetrical manner, cylinder V_1' is positioned so that $\alpha_1' = -\alpha_3$ (see Fig. 4) and $\alpha_1' = \alpha_3$. Using (12), this implies:

$$d\theta_1 = -d\theta_3, \quad (14)$$

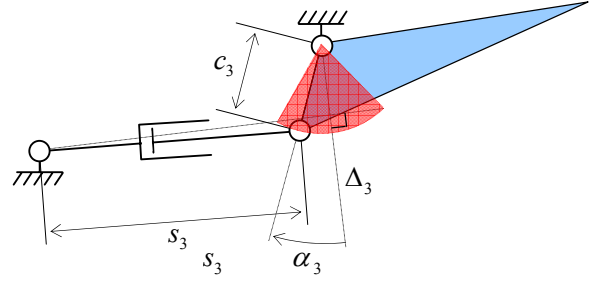

Fig. 5: Specific arrangement of cylinders.

Distal phalanxes are constrained to be perpendicular to the palm of the hand in their initial position (when no cylinder is powered) thanks to the use of springs and mechanical limits, which finally gives:

$$\theta_1 + \theta_3 = \frac{\pi}{2}, \quad (15)$$

2) Non-backdrivability

As stated in the previous section, at least four non-backdrivable mechanisms are needed for the TWIX hand to be form-closure capable. We choose to mount a piloted non-return valve on cylinders V_1 , V_2 and V_3 for both fingers. Such valves, when not powered, let the air flow in a single direction and when powered, in both directions. During phase 2, no non-return valve is powered, thus preventing all phalanxes from moving backward. During phase 1, only NRV_3 is powered, so that the cylinders V_3 and V_1' are connected to each other. All non-return valves are powered during the opening process of the hand to permit the release of the grasp.

Another advantage of using non-backdrivable mechanisms is that it suppresses the ejection phenomenon. In [16], the author demonstrates that, in some configurations of the finger, phalanx forces are negative. The finger is then not in static equilibrium because of unilateral contacts. This results in initiating an “ejection phenomenon”, which either stops when a so-called “equilibrium position” is reached or carries on until actual ejection occurs. Such a phenomenon is characterized by a backward motion of one or more phalanxes. In our case, the use of non-backdrivable mechanisms permits to avoid this phenomenon, since it prohibits all phalanxes from moving backward.

B. Optimal mechanical design of finger

The problematic of optimising the mechanical design of a 2-phalanx underactuated finger has been addressed in [17]. The author considers two issues, the isotropy of the grasp and the ejection phenomenon. As previously stated, the ejection phenomenon can not occur thanks to non-backdrivable mechanisms. However, positive forces are obviously preferred so that all phalanxes contribute to the grasp. A finger is said to be force isotropic when the intensity of forces exerted at the centre of each phalanx on the grasped object are identical. This property is of major importance to prevent damages to the object.

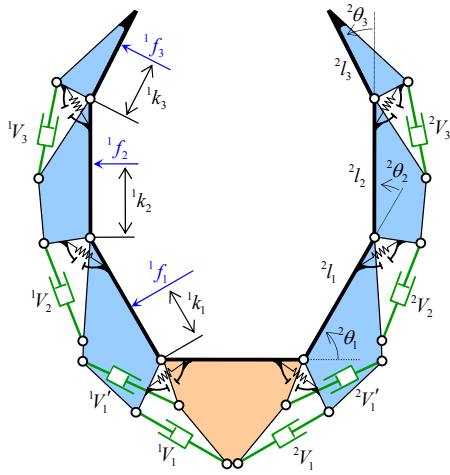

Fig. 6: Kinematic scheme of the TWIX Hand.

In order to simplify the problem, phalanges have been chosen with the same length. Only, the lengths of the lever arms (c_1, c_2, c_3) have been optimised according to the positiveness and the isotropy of phalanx forces.

The analytical expression of normal contact forces for an underactuated finger is given in [13]. However, this study is dedicated to fingers using “four-bar linkage” or “pulley-cable” mechanisms to achieve underactuation. Thus, expressions obtained for our hand are slightly different.

$$\mathbf{f} = \mathbf{J}_F^T \mathbf{T}^T \mathbf{t}, \quad (16)$$

where $\mathbf{f} = [f_1 \ f_2 \ f_3]^T$ is the vector of normal contact forces and $\mathbf{t} = [T_1 \ T_2 \ T_3]^T$ is the input torque vector exerted by the actuator and springs. \mathbf{J}_F is the jacobian matrix of the finger and \mathbf{T} the so-called transmission matrix.

$$\mathbf{J}_F = \begin{bmatrix} k_1 & 0 & 0 \\ k_2 + l_1 C_{\theta_2} & k_2 & 0 \\ k_3 + l_1 C_{\theta_2 + \theta_3} + l_2 C_{\theta_3} & k_3 + l_2 C_{\theta_3} & k_3 \end{bmatrix}, \quad (17)$$

where $C_\varphi = \cos(\varphi)$ and θ_i is the angle between the i^{th} phalanx and the previous one (the palm for the proximal phalanx). l_i is the length of the i^{th} phalanx and k_i is the contact location along the considered phalanx.

Using [18], the transmission matrix is

$$\mathbf{T}^T = \begin{bmatrix} h_1 + h_1' & 1 & 0 & 0 \\ h_2 & 0 & 1 & 0 \\ h_3 & 0 & 0 & 1 \end{bmatrix}, \quad (18)$$

$$\mathbf{t} = [p_0 S \ T_1 \ T_2 \ T_3]^T, \quad (19)$$

where S is the surface of the piston of cylinders. T_i is the spring torque exerted on the i^{th} phalanx. $h_i = c_i \cos(\alpha_i)$ is the effective lever arm of cylinder V_i , $h_1' = c_3 \cos(\alpha_1')$. The relation between α_i and θ_i is given by

$$\alpha_i = \theta_i + \beta_i \text{ and } \alpha_1' = \theta_1 + \beta_1', \quad (20)$$

where β_i depends on the angular range of θ_i . Given

$$\theta_1 \in \left[\frac{\pi}{4}; \frac{7\pi}{12} \right], \theta_2 \in \left[0; \frac{\pi}{3} \right] \text{ and } \theta_3 \in \left[-\frac{\pi}{12}; \frac{\pi}{3} \right], \quad (21)$$

one gets $\beta_1 = -\frac{5\pi}{12}$, $\beta_1' = -\frac{3\pi}{8}$, $\beta_2 = -\frac{\pi}{6}$, $\beta_3 = -\frac{\pi}{8}$.

Hence, the static equilibrium of the finger when grasping a fixed object assuming that all three phalanges are in contact, gives the following expressions for contact forces

$$f_1 = p_0 S \left[\frac{c_1 C_{\theta_1 + \beta_1} + c_3 C_{\alpha_1 + \beta_1'}}{k_1} - \frac{c_2 C_{\theta_2 + \beta_2} [k_2 + l_1 C_{\theta_2}]}{k_1 k_2} + \frac{c_3 l_1 C_{\theta_3 + \beta_3} [(k_3 + l_2 C_{\theta_3}) C_{\theta_2} - k_3 C_{\theta_2 + \theta_3}]}{k_1 k_2 k_3} \right], \quad (22)$$

$$f_2 = p_0 S \frac{c_2 k_3 C_{\theta_2 + \beta_2} - c_3 C_{\alpha_3 + \beta_3} (k_3 + l_2 C_{\theta_3})}{k_2 k_3}, \quad (23)$$

$$f_3 = p_0 S \frac{c_3 C_{\theta_3 + \beta_3}}{k_3}, \quad (24)$$

Some assumptions, namely negligible friction at the contacts and negligible spring torques between phalanges, have been made in order to obtain the above expressions. These assumptions remain effective in the following study. All phalanges have the same length.

1) Force positiveness

This section aims at defining conditions on $r_{23} = c_2/c_3$ and $r_{13} = c_1/c_3$ that ensure the positiveness of contact forces on the domain $(\theta_1, \theta_2, \theta_3)$. Therefore, we define a criterion η_i that is the percentage of the domain $(\theta_1, \theta_2, \theta_3)$ for which f_i is positive.

The conclusion for the distal phalanx is direct since $f_3 > 0, \forall \theta_3 \in \left[-\frac{\pi}{12}; \frac{\pi}{3} \right]$, thus $\eta_3 = 1$. Using (23), Fig. 7 is drawn and a condition is deduced on r_{23} so that $\eta_2 = 1$:

$$r_{23} \geq 3.4, \quad (25)$$

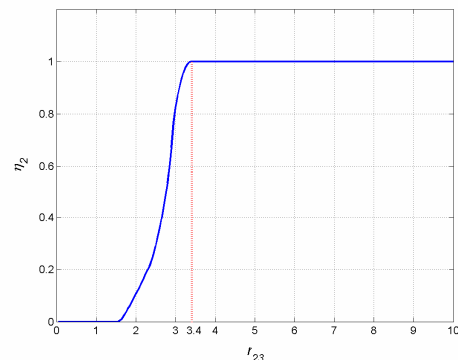

Fig. 7: Representation of η_2 , namely the percentage of the domain $(\theta_1, \theta_2, \theta_3)$ for which f_2 is positive, as a function of $r_{23} = c_2/c_3$.

In the same manner, η_1 is represented on Fig. 8 as a function of r_{13} and r_{23} . Thus, with $r_{23} = 3.4$, r_{13} has to be chosen $r_{13} \geq 7.4$ so that $\eta_1 = 1$.

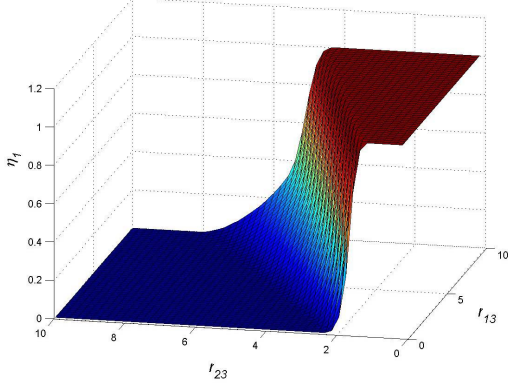

Fig. 8: Representation of η_1 as a function of r_{13} and r_{23} .

2) Force isotropy

In [8], the author presented a cam-tendon device providing equal phalanx forces whatever the configuration of the finger. However, the property of force isotropy is generally local, indeed phalanx forces present high variations depending on the finger configuration. Therefore, the criterion introduced in [17] is used in order to quantify the force-isotropy of the finger:

$$\kappa_{ij} = \sqrt{\left(\frac{f_i - f_j}{f_j}\right)^2}, \quad (26)$$

It should be noted that the phalanx force actually exerted on the object is considered null when the computed force is negative. A minimum of $\overline{\kappa_{23}} = 40\%$ is obtained for $r_{23} = 3,7$. In the same manner, if $r_{23} = 3,7$, $\overline{\kappa_{13}}$ is minimal (4 %) for $r_{13} = 7,5$.

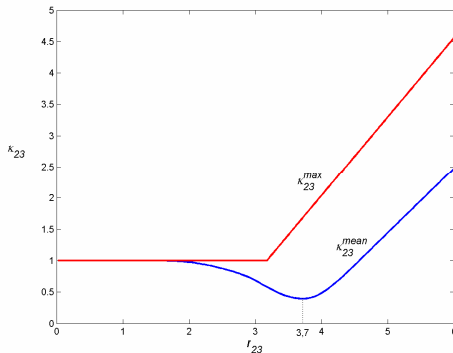

Fig. 9: $\overline{\kappa_{23}}$ and κ_{23}^{\max} as a function of r_{23} .

3) Design constraints

Given the maximal stroke s_{\max} of cylinders and the angle clearance $\Delta\theta_i$ of the bar c_i , an upper limit on the length of c_i is

$$c_i \leq \frac{s_{\max}}{2 \sin(\Delta\theta_i/2)}, \quad (27)$$

Since cylinders have a maximal stroke of 17,7 mm, one obtains the following constraint:

$$c_1, c_2, c_3 \leq 17,7 \text{ mm}, \quad (28)$$

C. Conclusion

Considering all the performance criteria and design constraints defined in this section, the following lengths have been chosen

$$c_1 = 17,7 \text{ mm}, c_2 = 9,8 \text{ mm and } c_3 = 2,4 \text{ mm} \quad (29)$$

$$r_{13} = 7,5 \text{ and } r_{23} = 3,7 \quad (30)$$

The following performances can be expected from the fingers:

Criterion	Result
η_1	100 %
η_2	100 %
η_3	100 %
$\overline{\kappa_{13}}$	4 %
κ_{13}^{\max}	310 %
$\overline{\kappa_{23}}$	40 %
κ_{23}^{\max}	166 %

Tab. 1: Expectable performances of the finger using $r_{13} = 7,5$ and $r_{23} = 3,7$.



Fig. 10: The TWIX hand performing an enveloping grasp on the left and a fine pinch grasp on the right.

V. CONCLUSION

In this paper, a new pneumatically driven underactuated hand has been presented. Non-backdrivable mechanisms, have been introduced in the transmission of motion of phalanxes, so that the hand is form-closure capable. This has been justified using a newly developed method that permits to study the form-closure of a grasp exerted by an underactuated hand. Furthermore, the use of non-backdrivable mechanisms highly contributes to improve the

overall stability of the fingers since it suppresses the ejection phenomenon by prohibiting any backward motion of phalanxes. Finally, the optimal design of fingers has been presented. Therefore, two properties have been considered that are the positiveness of phalanx forces and the force-isotropy of the fingers.

REFERENCES

- [1] S. C. Jacobsen, E. K. Iversen, D. F. Knutti, R. T. Johnson, and K. B. Biggers, "Design of the UTAH/MIT dextrous hand," in *Proc. of ICRA86: IEEE International Conference on Robotics and Automation*, San Francisco, CA, USA, 1986, pp. 1520–1532.
- [2] J. K. Salisbury and J. J. Craig, "Articulated hands: Force control and kinematic issues," *The International Journal of Robotics Research*, Vol. 1, No. 1, pp. 4-17, 1982.
- [3] G. Bekey, R. Tomovic, and I. Zeljkovic, "Control architecture for the Belgrade/USC Hand," in *Dextrous Robot Hands*, S.T. Venkataraman and T. Iberall (Ed.), Springer-Verlag, 1989.
- [4] J. Butterfass, M. Grebenstein, H. Liu, and G. Hirzinger, "DLR-hand II: next generation of a dextrous robot hand," in *proc. of ICRA 2001: IEEE International Conference on Robotics and Automation*, Seoul, Korea, May 1-26, 2001, pp. 109-114.
- [5] W.T. Townsend, "The BarrettHand grasper – programmably flexible part handling and assembly," *Industrial Robot: An International Journal*, MCB University Press, Vol. 27, No. 3, pp. 181–188, 2000.
- [6] B. Massa, S. Roccella, M. C. Carrozza, and P. Dario, "Design and Development of an Underactuated Prosthetic Hand," in *Proc. Of ICRA2002: IEEE International Conference on Robotics & Automation*, Washington, DC, May 2002, pp. 3374-3379.
- [7] T. Laliberté, L. Birglen, and C. Gosselin, "Underactuation in Robotic Grasping Hands," *Japanese Journal of Machine Intelligence and Robotic Control*, Special Issue on Underactuated Robots, pp. 77-87, Vol. 4, No. 3, September 2002.
- [8] S. Krut, "A force-isotropic underactuated finger," in *Proc. of ICRA2005: IEEE International Conference on Robotics & Automation*, Barcelona, Spain, April 2005, pp. 2325-2330.
- [9] V. Bégoc, S. Krut, E. Dombre, F. Pierrot and C. Durand, "On the form-closure capability of underactuated hands," in *Proc. of ICARCV 2006: IEEE international conference on Control, Automation, Robotics and Vision*, Singapore, December 2006.
- [10] R. Olfati-Saber, "Nonlinear control of underactuated mechanical systems with application to robotics and aerospace vehicles," Thesis, Department of Electrical Engineering and Computer Science, Massachusetts Institute of Technology, Cambridge, MA, February 2001.
- [11] Hirose S., "Connected Differential Mechanism and its Applications", in *Proc. of Int. Conf. of Advanced Robotics*, Tokyo, Japan, September 1985.
- [12] A. Bicchi and V. Kumar. "Robotic Grasping and Manipulation." In S. Nicosia, B. Siciliano, A. Bicchi, and P. Valigi (eds.), editors, *Ramsete: Articulated and mobile robots for services and Technology*, volume 270, chapter 4, pages 55-74. Springer-Verlag, Berlin Heidelberg, Germany, 2001.
- [13] L. Birglen and C. Gosselin, "Kinetostatic analysis of underactuated fingers," *IEEE Transactions on Robotics and Automation*, vol. 20, no. 2, pp. 211-221, April 2004.
- [14] F.Reuleaux, *Kinematics of machinery*, New York: Dover, 1963. First published in German, 1875.
- [15] P. Somov, "Über Gebiete von Schraubengeschwindigkeiten eines starren Körpers bei verschiedener Zahl von Stützflächen," *Zeitschrift für Mathematik und Physik*, vol. 45, 1900.
- [16] Birglen, L. and Gosselin, C. M., "On the Force Capability of Underactuated Fingers," in *Proc. Of ICRA2003: IEEE International Conference on Robotics & Automation*, Taipei, Taiwan, September, 2003.
- [17] L. Birglen and C. Gosselin, "Optimal design of 2-phalanx underactuated fingers," in *Proc. of IMG2004: IEEE international conference on Intelligent Manipulation and Grasping*, Gênes, Italy, pages 110-116, July 2004.
- [18] L. Birglen and C. Gosselin, "Force analysis of connected differential mechanisms: application to grasping," *International Journal of Robotics Research*, to appear in 2007.