



HAL
open science

Wavelet Based Data-Hiding of DEM in the Context of Real Time 3D Visualization

Khizar Hayat, William Puech, Gilles Gesquière, Marc Chaumont

► **To cite this version:**

Khizar Hayat, William Puech, Gilles Gesquière, Marc Chaumont. Wavelet Based Data-Hiding of DEM in the Context of Real Time 3D Visualization. *Electronic Imaging*, Jan 2007, San Jose, CA, United States. pp.64950N, 10.1117/12.703040 . lirmm-00192902

HAL Id: lirmm-00192902

<https://hal-lirmm.ccsd.cnrs.fr/lirmm-00192902>

Submitted on 29 Nov 2007

HAL is a multi-disciplinary open access archive for the deposit and dissemination of scientific research documents, whether they are published or not. The documents may come from teaching and research institutions in France or abroad, or from public or private research centers.

L'archive ouverte pluridisciplinaire **HAL**, est destinée au dépôt et à la diffusion de documents scientifiques de niveau recherche, publiés ou non, émanant des établissements d'enseignement et de recherche français ou étrangers, des laboratoires publics ou privés.

Wavelet Based Data-Hiding of DEM in the Context of Real Time 3D Visualization

K. Hayat^a, W. Puech^a, G. Gesquiere^b and M. Chaumont^a

^aLIRMM Laboratory, UMR CNRS 5506, University of Montpellier II
161, rue Ada, 34392 MONTPELLIER CEDEX 05, FRANCE

^bLSIS Laboratory, UMR CNRS 6168, Aix-Marseille University
IUT, rue R. Follereau, 13200 ARLES, FRANCE

ABSTRACT

The use of aerial photographs, satellite images, scanned maps and digital elevation models necessitates the setting up of strategies for the storage and visualization of these data in an interactive way. In order to obtain a three dimensional visualization it is necessary to map the images, called textures, onto the terrain geometry computed with Digital Elevation Model (DEM). Practically, all of these informations are stored in three different files: DEM, texture and geo-localization of the data. In this paper we propose to save all this information in a single file for the purpose of synchronization. For this, we have developed a wavelet-based embedding method for hiding the data in a color image. The texture images containing hidden DEM data can then be sent from the server to a client in order to effect 3D visualization of terrains. The embedding method is integrable with the JPEG2000 coder to accommodate compression and multi-resolution visualization.

Keywords: 3D visualization, data-hiding, JPEG2000 compression, digital elevation model, Geographical Information System.

1. INTRODUCTION

The Geographical Information Systems (GIS) are appreciably utilized in the domain of decision making in a number of enterprises and institutions. These GIS enable us to combine textual data, vectorial data and images (rasters). The utilization of data like aerial photographs, scanned maps or digital elevation models implies the setting up of strategies for the storage and visualization of these data.¹ In particular, it becomes difficult to store all these data on every computer/terminal especially if it is a low capacity media, e.g. a pocket PC. Moreover this storage problem is amplified by the technological evolution of the sensors which makes it possible to obtain images of better quality and thus of increasingly significant size. For example, it is currently possible to have aerial/satellite images whose precision is finer than one meter. However, these data must be optimally transferred from the server towards a client application. For the area of Bouches du Rhône*, for example, the aerial photographs represent more than six Giga Bytes of information compressed by JPEG2000. In addition, the visualization of a terrain in three dimensions implies to map the image of the ground onto the terrain geometry made with digital elevation model (DEM). This linking is possible by geo-referencing the coordinates of these elements. All this information is in general stored in three different files: DEM, texture and geo-referencing system employed. The objective of this work is to develop an approach allowing us to decompose the 3D information at various resolution levels and embedding the resulting data in the related image which is itself decomposed at different resolution levels. This would enable each client to download data at a resolution compatible with its capacity and requirements. The aim is to store and synchronize all of this information in only one file in order to develop a client-server application for 3D real-time visualization. From this approach it is possible to transmit only one file containing all the information and depending only on the area where we are. A particular level of detail is selected for transmission depending on the data transfer rate and the point of view of the 3D visualization. In order to store all of the information in a single file, without developing any new proprietary format and maintaining compressions performances, we propose in this paper the use of wavelet

khizar.hayat@lirmm.fr, william.puech@lirmm.fr, gilles.gesquiere@lsis.org, marc.chaumont@lirmm.fr

*In the south of France.

based embedding methods for data hiding.² This work is a follow up of a previous one based on DCT (Discrete Cosine Transform).³

This paper is organized in the following manner. In section 2 we introduce the digital elevation models and their 3D textured visualization. Section 3 envisages the wavelet decomposition of an image and our proposed embedding method for data hiding. Finally, section 4 presents the application of our method to real data and the analysis of the results obtained.

2. REPRESENTATION OF TERRAINS IN 3D

Nowadays, three dimensional terrain visualization is important, for example, for decision makers, 3D urban models, flight and driving simulators, and more generally, multi-player applications. In the context of our work we are interested in the real-time 3D visualization of terrains. This leads us to the fact of combining two types of data.¹ In the first place we utilize a range of altitudes. Each altitude corresponds to an elevation (Figure 1.a). These are the ones utilized for the generation of the terrain geometry, by connecting them, for example, to obtain a triangular mesh (Figure 1.b). We must subsequently map the corresponding image onto these triangles in order to obtain the desired visualization (Figure 1.c).

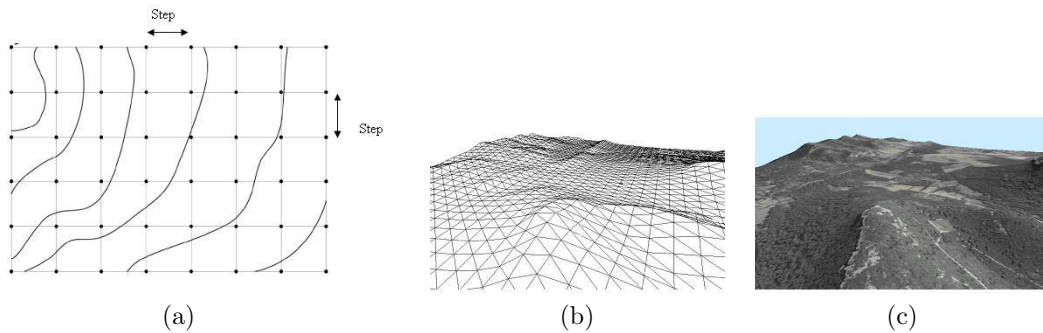

Figure 1. a) Visualization of the uniform grid corresponding to the elevations of the terrain, b) 3D triangulated surface linking the elevations, c) Texture mapping with ortho-photographs onto the geometry.

2.1. Digital Elevation Model (DEM)

In order to represent the altitudes corresponding to each point of a terrain in three dimensions, a range of elevations is utilized. A regular grid which has a step size of one altitude every 50 meters can be used (Figure 1.a). The points are then linked for building the triangles. The number of these triangles is very important. For example, more than 10 millions triangles are necessary for the department of Bouches du Rhône (having an area of around 13000 Km^2) in France.

Many methods have been proposed to reduce the number of triangles provided by a uniform discretization, while preserving a good approximation of the original surface. One main approach consists in obtaining an irregular set of triangles (TIN: Triangulated Irregular Network). There are a number of techniques to create this set of triangles, for example the Delaunay triangulation.⁴ Hierarchical representations of these triangulations have been proposed thus making it possible to introduce the concept of the levels of detail.⁵ It is thus possible to obtain various levels of surfaces with an accuracy which is similar to a uniform grid but with a lower number of triangles. Another approach involves the breaking up of the terrain into a set of nested regular grid at different levels of detail.¹

2.2. Application of textures

Once the geometric construction is effected, it is necessary to map the texture onto the triangles, obtained from the elevations. The precision linked with such images is generally more accurate than one pixel per 50 *cm*

on the ground, which induces a significant cost in relation to the storage and transfer of the images to the client. It is therefore necessary to think of the strategies of compression, storage and visualization speed of these data. Among the various existing methods of image compression, the more efficient ones like JPEG introduce deterioration of the image quality for high compression rates. There are many methods of image compression, most powerful in terms of compression ratio, if we are allowed to degrade the image quality, being JPEG and JPEG2000. Several client- server architectures have been proposed to store significant size of data often used on several terminals.⁶ In order to quickly visualize the data, a strategy consists of cutting a set of images in a nested regular grid,⁷ itself decomposed at various levels of detail.⁸

3. DATA HIDING IN THE WAVELET DOMAIN

In this work we have borrowed, from the JPEG2000 compression standard, only the step concerned with the discret wavelet transform (DWT). The implementation is based on the lifting method.^{9,10} We have employed both the JPEG2000 supported wavelets, i.e. the reversible Daubechies (5/3) and the irreversible Daubechies (9/7).¹¹ Our objective is to visualize, on a client application, a terrain defined by the given elevations and their corresponding texture. This data is stored on a distant server and sent in small-sized packets in order to minimize the waiting time. We have used the data compiled by the IGN France[†] which is generally stored in three different files: the DEM, the texture and the system of coordinates employed. In order to store all of these information in a single file, we propose to embed the DEM as well as the geo-referential coordinates in the texture. An information of altitude is thus synchronized with a corresponding pixel block of the texture.

We choose to use JPEG2000 format for fully exploiting the property of multilevel resolution for scalability purposes. Many methods have been proposed for wavelet-based data hiding but few of these are compatible with the JPEG2000 scheme. According to Ref. 2, data hiding methods for JPEG2000 images must process the code blocks independently and that is why methods like inter-subband embedding,¹² hierarchical multi-resolution embedding¹³ and correlation-based method¹⁴ as well as non-blind methods have not been recommended. Xia¹⁵ and Kundur¹⁶ have embedded invisible watermarks by adding pseudorandom codes to large coefficients of the high and middle frequency bands of DWT but the methods have the disadvantage of being non-blind. The blind scheme proposed in Ref. 17 is to integrate data hiding with the EBCOT (Embedded Block Coding with Optimized Truncation) and embed data during the formation of compressed bit stream. The scheme is claimed to have robustness and good perceptual transparency. In Ref. 18 watermark is embedded in the JPEG2000 pipeline after the stages of quantization and ROI scaling but before the entropy coding. For reliability purposes the finest resolution subbands have been avoided. A window sliding approach is adopted for embedding with the lowest frequencies having higher payload. Piva *et al*¹⁹ has proposed the embedding of image digest in a DWT based authentication scheme where the data is inserted in the layers containing the metadata. An $N \times N$ image is first wavelet transformed and the resultant LL subband is passed to DCT domain. The DCT coefficients are scaled down and of these some are likely to be most significant. After further scaling the DCT coefficients are substituted to the higher frequency DWT coefficient and the result is inverse DWTTed to get the embedded image. One blind method²⁰ transforms the original image X by one-level wavelet transform and sets the three higher subbands to zero before inverse transforming it to get the reference image Y. The difference values between X and Y are used to ascertain the potential embedding locations of which a subset is selected randomly for embedding. The method of Kong *et al*²¹ embeds watermark in the weighted mean of the wavelets blocks, rather than in the individual coefficient, to make it robust and perceptually transparent. While explaining their method of embedding biometric data in fingerprint images, Noore *et al*²² argue against the modification of the lowest subband to avoid degradation of the reconstructed image as most of the energy is concentrated in this band. Instead they propose to redundantly embed information in higher frequency bands.

In order to embed the information about the altitude in the texture map, we propose to follow the protocol illustrated in Figure 2. From a N^2 pixel texture image and the corresponding map of m^2 altitudes, we deduce the embedding factor $E = m^2/N^2$ coefficients per pixel. The image of texture will have therefore to be divided into square blocks of size equal to $[1/E]$ pixels and every such block would hide one altitude coefficient. The texture is transformed from the RGB space to the YCrCb space in the first place. A discrete wavelet transformation

[†]The Institut Geographique National

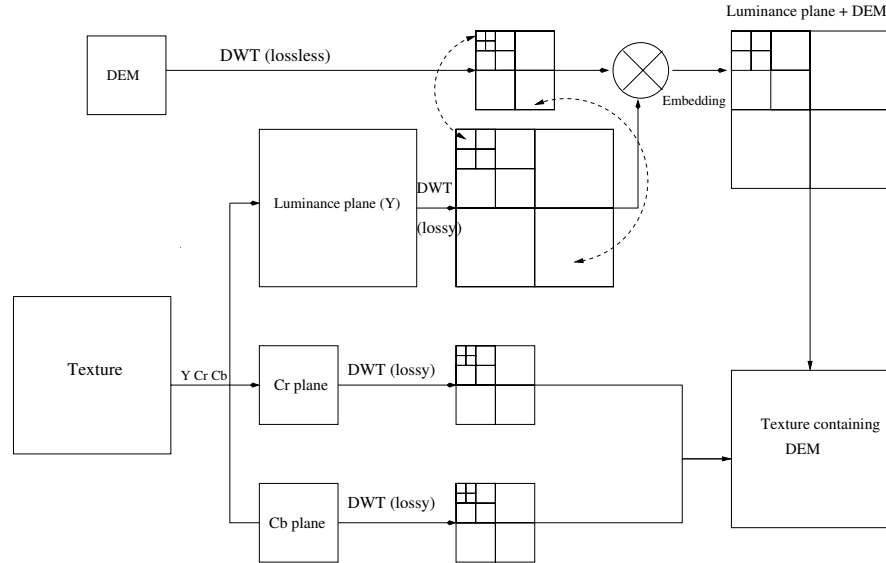

Figure 2. Description of the Method Embedding DEM in the Texture.

(DWT) is individually applied to the three resultant planes as well as the altitude map. For the latter we chose to employ the lossless decomposition of Daubechies 5/3 to avoid altering of the altitude values.

To ensure a spatial coherence between the altitudes and the texture, we decompose the luminance plane Y in the wavelet domain, at a particular level of resolution, and divide it into square blocks of $[1/E]$ coefficients. In each block we embed one information of altitude at the same level of decomposition. We thus achieve a synchronization in the embedding as far as the incremental levels of the wavelets are concerned. For example, low resolution coefficients of the altitude map are embedded in the low resolution sub-bands of texture. In this way the transmission of the part concerned with the low resolution of the texture map enables us to directly access the corresponding low resolution part of the altitude map. The embedding data are carried out by modifying the least significant bits of a certain number of coefficients of the luminance plane of the texture. These coefficients are chosen by using a pseudo random number generator. At the reception the DEM is recovered from the texture, even if only a part of the image of texture has been transmitted.

4. RESULTS

We have applied our method to a texture map of the Bouches du Rhône, having a size of 2048×2048 pixels and illustrated in Figure 3.b, with the associated altitude map of 64×64 coefficients, illustrated in Figure 3.a. A 128×128 pixel detail of the above mentioned image of texture is represented in Figure 3.c. Each coefficient of the altitude is coded with 2 bytes implying the embedding factor of 1 coefficient per 32×32 pixels of texture.

By effecting lossy wavelet decompositions on the texture map and lossless on the map of altitudes we obtained the results illustrated in Figures 4 for level 1, in Figures 5 for level 2, and Figures 6 for level 3 transformation. For the DWT at the first level, Figure 4.a, the embedding has been done in four parts (LL, LH, HL and HH) whereas for level 3, wavelet decomposition (Figure 6.a) the embedding of data has been realized in ten steps. Hence, in general, the data embedding at level l decomposition takes place in $3l + 1$ parts. No matter what is the level of decomposition, the difference between the images of luminance before and after data embedding gave us a PSNR of 69.20 dB since one 16 bit coefficient of the altitude are embedded per 32×32 coefficients of the Y component of texture.

From the texture decomposed up to third level and embedded with the altitudes, if we apply an inverse DWT solely to the image of approximation (the lowest sub-band) of level 3, we obtain a texture illustrated

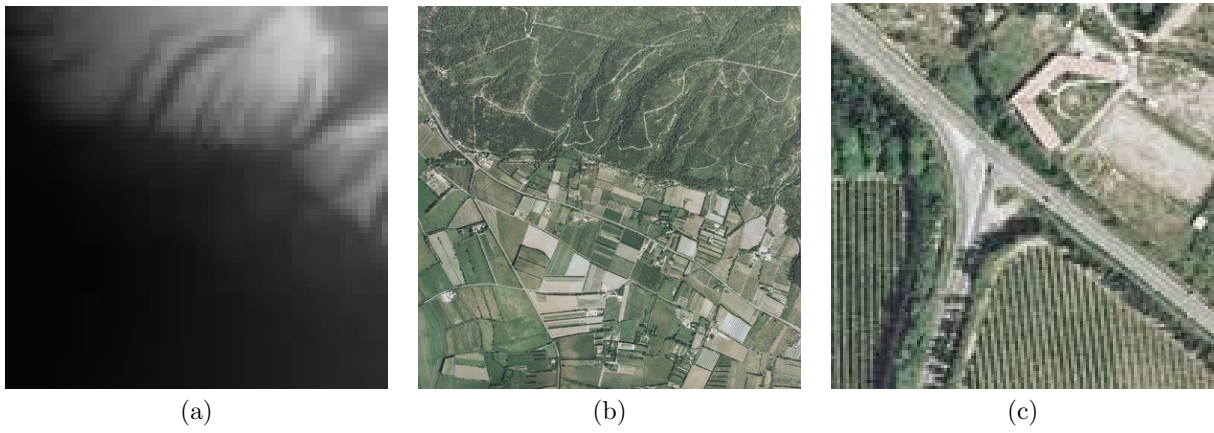

Figure 3. Original Images: a) Altitudes, b) Texture, c) A part of texture magnified.

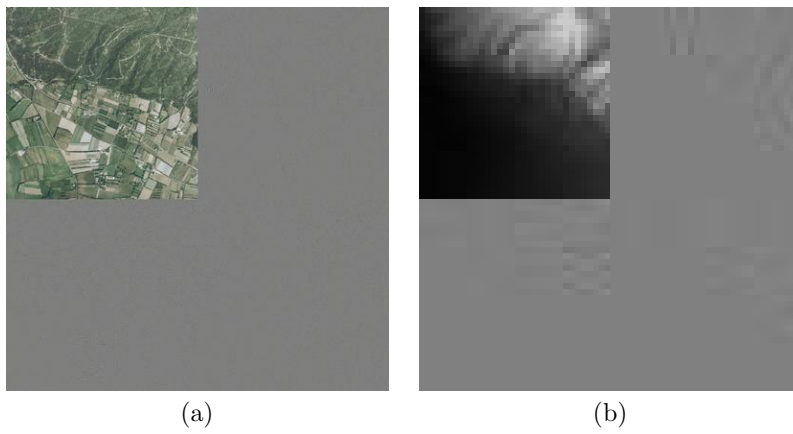

Figure 4. DWT at level 1: a) Texture, b) Altitudes.

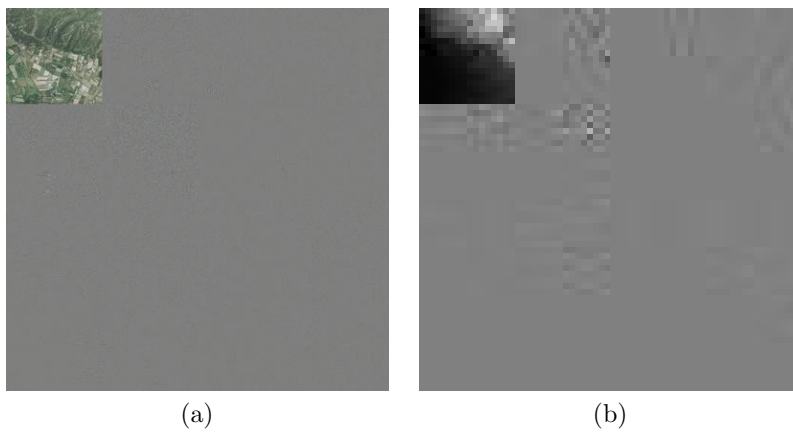

Figure 5. DWT at level 2: a) Texture, b) Altitudes.

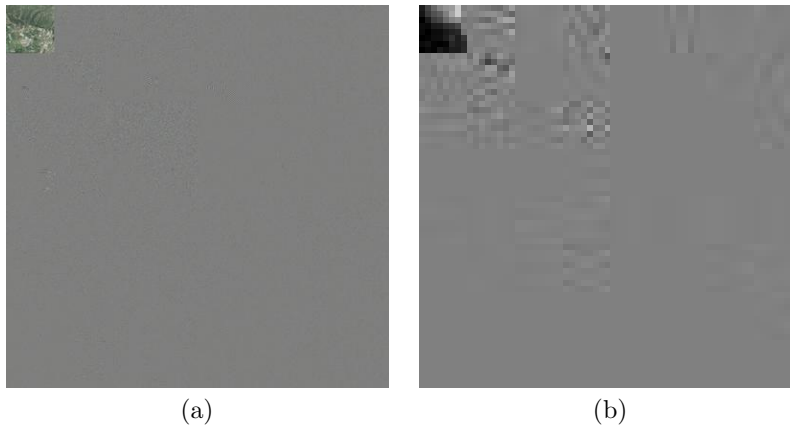

Figure 6. DWT at level 3: a) Texture, b) Altitudes.

in Figure 7.b. By computing the difference between this reconstructed texture and the original one we obtain a PSNR of 20.90 *dB*. The detailed portion of Figure 3.c can be compared with the rebuilt one illustrated in Figure 7.c. From the image of approximation of level 3, if the extraction of the embedded data is followed by an inverse DWT we obtain the altitudes map given in Figure 7.a. The PSNR between the original altitude and the reconstructed one is then found to be 29.25 *dB*. It must be noted over here that the image of approximation of level 3 corresponds only to 1,6% of the initial data.



Figure 7. Reconstruction of the images from the image of approximation at Level 3: a) Extracted altitude, b) Texture, c) Magnified part of texture corresponding to that of Fig.3.b.

Table 1 summarizes the results obtained for a reconstruction from the images approximation of levels 1, 2 and 3 or by utilizing all the data. Note that if we use all the data for the inverse *DWT*, a PSNR of 37.62 *dB* for the texture is resulted in contrast to an infinite PSNR for the altitude map since we utilized a lossless inverse *DWT* for the last one. The Figures 8.a and b show the altitude maps reconstructed respectively from the images of approximation of levels 2 and 1. The differences between the original altitudes and the reconstructed one are illustrated in the Figures 10 for the levels 1, 2 and 3.

The Figure 9.a represents the 3D reconstruction of the DEM from all the initial data, whereas Figures 9.b, c and d show those from the images of approximation of level 1, 2 and 3 respectively. By mapping the texture onto the corresponding DEM, one can compare the final result between a visualization with all the data (Figure 11.a) and a visualization only with the level 3 (Figure 11.b) composed of 1.6 % of the initial data.

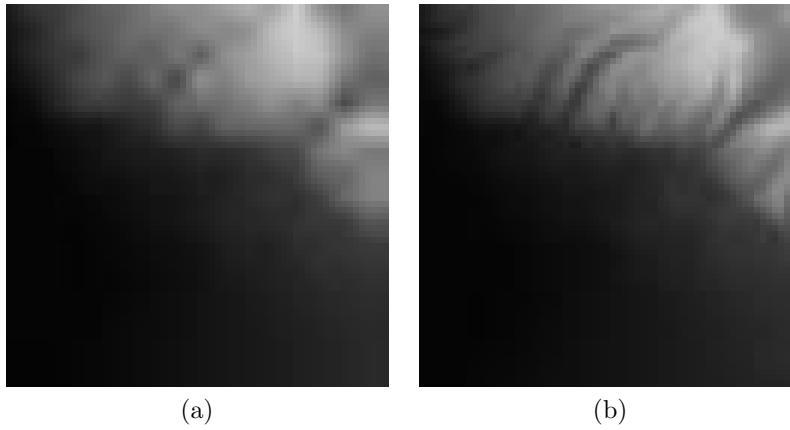

Figure 8. Reconstruction of altitude map from the approximation image of: a) Level 2, b) Level 1.

	lev. 3	lev. 2	lev. 1.	lev. 0
% transmitted data	1.6 %	6.25 %	25 %	100 %
Texture (dB)	20.90	22.79	26.54	37.62
Altitude (dB)	29.25	33.51	40.37	∞
\sqrt{MSE} Altitude (m)	8.80	5.39	2.44	0

Table 1. Results obtained after the extraction and reconstruction as a function of the used data (for level 0, all of the data are used for DWT).

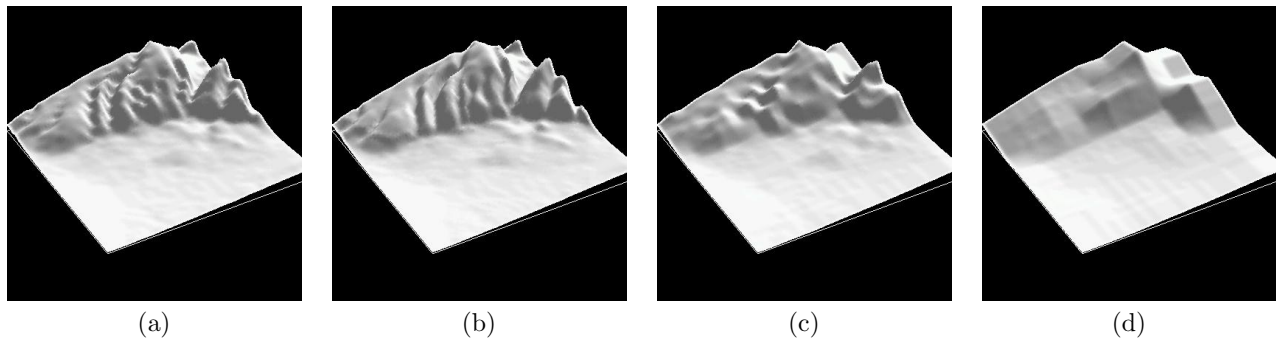

Figure 9. 3D visualization of the Altitude with lowest frequency sub-band: a) With all the information - level 0, b) Level 1, c) Level 2, d) Level 3.

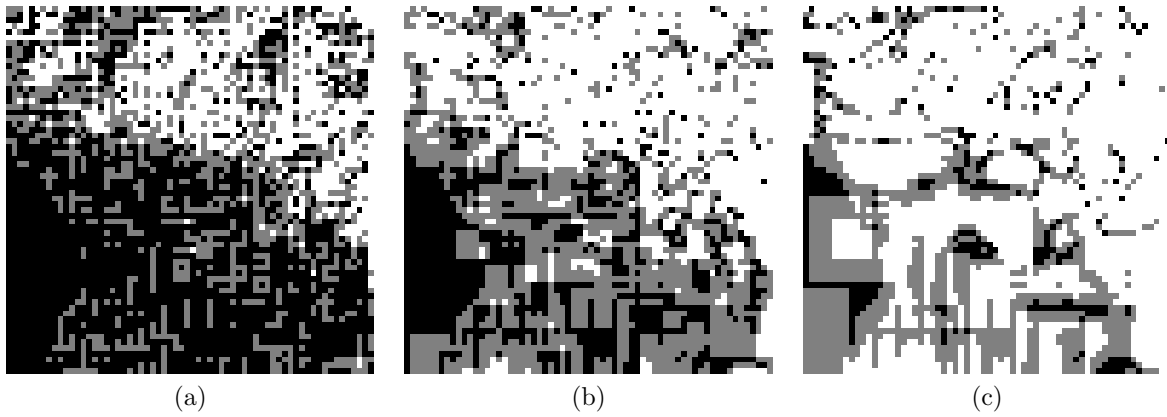

Figure 10. Differences between the original altitudes and the reconstructed ones: a) Level 1, b) Level 2 c) Level 3.

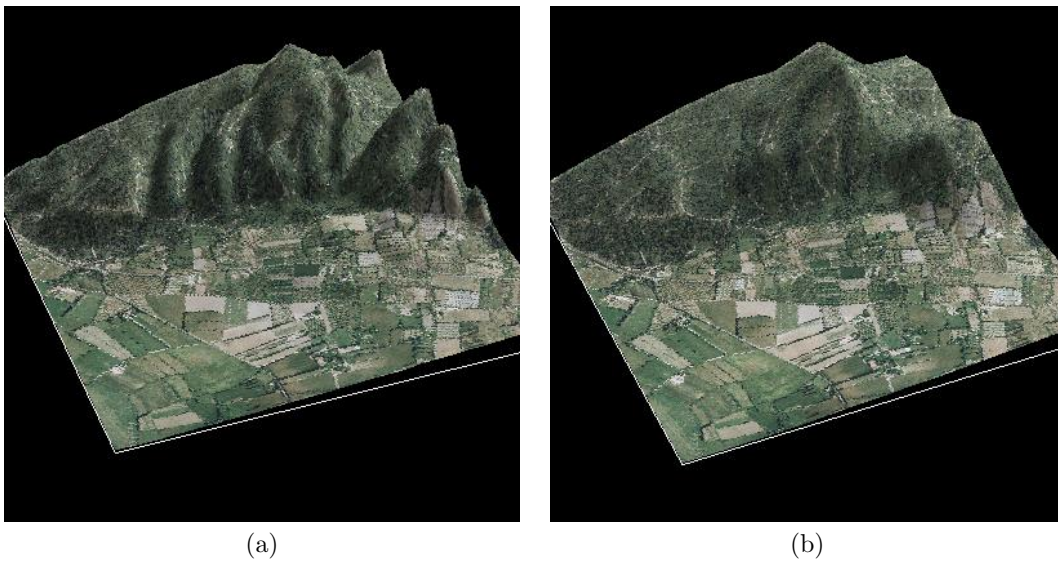

Figure 11. 3D navigation of the area with: a) All the data, b) Level 3, lowest sub-band data.

5. CONCLUSION

In this paper we presented a method of data embedding that conceal a DEM inside its corresponding orthophotograph. In the context of the client-server application that we established, we can thus synchronize these informations, thus avoiding all the errors linked with any erroneous combination of data or a breach in their transfer. Moreover, the use of compressed images in the form of wavelets allows for the transfer of the necessary levels for an optimal visualization as a function of the point of view chosen by the user, of the data flow rate, of the media utilized (PC, pocket PC, Palm Pilot, smart phone etc.) and of the level of detail chosen. In addition, the developed method of data insertion is integrable with the JPEG2000 coder, which indicates that the images of texture could be visualized using any the JPEG2000 image viewers.

Despite having obtained interesting results, we would like, in the continuation of our work, to set up a more fine DEM storage. We will also study the possibility of using a non-uniform grid on various levels of details, thus allowing us to decrease the number of triangles necessary for a good representation of the terrain wherever variations in the terrain are not very important. Even in the domain of wavelets one can go further and, for example, explore the geometric wavelets.

REFERENCES

1. F. Losasso and H. Hoppe, "Geometry Clipmaps: Terrain Rendering Using Nested Regular Grids," *ACM Trans. Graph.* **23**(3), pp. 769–776, 2004.
2. P. Meerwald and A. Uhl, "A Survey of Wavelet-domain Watermarking Algorithms," in *Proceedings of SPIE, Electronic Imaging, Security and Watermarking of Multimedia Contents III*, P. W. Wong and E. J. Delp, eds., **4314**, SPIE, IS&T, (San Jose, CA, USA), January 2001.
3. A. Martin, G. Gesquiere, W. Puech, and S. Thon, "Real Time 3D Visualisation of DEM Combined with a Robust DCT Based Data-Hiding Method," in *Electronic Imaging, Visualization and Data Analysis, SPIE, IS&T, San Jose, CA, USA*, **6060**, pp. 60600G–1–60600G–8, Jan 2006.
4. R. J. Fowler and J. J. Little, "Automatic Extraction of Irregular Network Digital Terrain Models," in *SIGGRAPH '79: Proceedings of the 6th annual conference on Computer graphics and interactive techniques*, pp. 199–207, ACM Press, (New York, NY, USA), 1979.
5. L. D. Floriani and E. Puppo, "Hierarchical Triangulation for Multiresolution Surface Description," *ACM Trans. Graph.* **14**(4), pp. 363–411, 1995.
6. P. Baumann, P. Furtado, R. Ritsch, and N. Widmann, "Geo/Environmental and Medical Data Management in the RasDaMan System," in *VLDB'97, Proceedings of 23rd International Conference on Very Large Data Bases, August 25-29, 1997, Athens, Greece*, M. Jarke, M. J. Carey, K. R. Dittrich, F. H. Lochovsky, P. Loucopoulos, and M. A. Jeusfeld, eds., pp. 548–552, Morgan Kaufmann, 1997.
7. J. Yu and D. J. DeWitt, "Processing Satellite Images on Tertiary Storage: A Study of the Impact of Tile Size on Performance," in *5th NASA Goddard Conference on Mass Storage Systems and Technologies*, 1996.
8. P. Hansen, "OpenGL Texture-Mapping with Very Large Datasets and Multi-Resolution Tiles," in *SIGGRAPH '99: ACM SIGGRAPH 99 Conference abstracts and applications*, p. 262, ACM Press, (New York, NY, USA), 1999.
9. W. Sweldens, "The Lifting Scheme: a New Philosophy in Biorthogonal Wavelet Constructions," in *Electronic Imaging, Wavelet Applications in Signal and Image Processing, SPIE, IS&T, San Diego, CA, USA*, **2569**, pp. 68–79, Sep. 1995.
10. S. Mallat, *A Wavelet Tour of Signal Processing*, Academic Press, 1998.
11. I. Daubechies and W. Sweldens, "Factoring Wavelet Transforms into Lifting Steps," *Fourier Anal. Appl.* **4**(3), 1998.
12. D. Kundur, "Improved Digital Watermarking Through Diversity and Attack Characterization," in *ACM Workshop on Multimedia Security'99, Orlando, FL, USA*, pp. 53–58, Oct 1999.
13. D. Kundur and D. Hatzinakos, "Digital Watermarking Using Multiresolution Wavelet Decomposition," in *International Conference on Acoustic, Speech and Signal Processing (IEEE ICASP 98), Seattle, Washington, USA*, **5**, pp. 2969–2972, (Seattle, Washington, U.S.A.), May 1998.

14. H.-J. Wang and C.-C. Kuo., “ An Integrated Approach to Embedded Image Coding and Watermarking,” in *IEEE ICASSP*, (Seattle, WA, USA), 1998.
15. X.-G. Xia, C.-G. Boncelet, and G. Arce, “A multiresolution Watermark for Digital Images,” in *ICIP*, 1997.
16. D. Kundur and D. Hatzinakos, “A Robust Digital Image Watermarking Scheme Using the Wavelet-Based Fusion,” in *IEEE Signal Processing Society 1997 International Conference on Image Processing (ICIP'97)*, (Santa Barbara, California), October 1997.
17. P.-C. Su, H.-J. Wang, and C.-C. J. Kuo, “An Integrated Approach to Image Watermarking and JPEG-2000 Compression,” *Journal of VLSI Signal Processing Systems, Special issue on multimedia signal processing* **27**(1-2), pp. 35–53, June 1997.
18. P. Meerwald, “Quantization watermarking in the JPEG2000 coding pipeline,” in *Communications and Multimedia Security Issues of The New Century, IFIP TC6/TC11 Fifth Joint Working Conference on Communications and Multimedia Security, CMS '01*, J. D. Ralf Steinmetz and M. Steinebach, eds., pp. 69–79, Kluwer Academic Publishing, (Darmstadt, Germany), May 2001.
19. A. Piva, F. Bartolini, and R. Caldelli, “Self Recovery Authentication of Images in The DWT Domain,” *Int. J. Image Graphics* **5**(1), pp. 149–166, 2005.
20. J.-L. Liu, D.-C. Lou, M.-C. Chang, and H.-K. Tso, “A Robust Watermarking Scheme Using Self-Reference Image,” in *Computer Standards & Interfaces*, **28**, pp. 356–367, 2006.
21. X. Kong, Y. Liu, H. Liu, and D. Yang, “Object Watermarks for Digital Images and Video,” in *Image and Vision Computing*, **22**, pp. 583–595, 2004.
22. A. Noore, R. Singh, M. Vatsa, and M. M. Houck, “Enhancing Security of Fingerprints through Contextual Biometric Watermarking,” in *Forensic Science International*, 2006.