



HAL
open science

r -hued $(r + 1)$ -coloring of planar graphs with girth at least 8 for $r \geq 9$

Xuan Hoang La, Mickaël Montassier, Alexandre Pinlou, Petru Valicov

► To cite this version:

Xuan Hoang La, Mickaël Montassier, Alexandre Pinlou, Petru Valicov. r -hued $(r + 1)$ -coloring of planar graphs with girth at least 8 for $r \geq 9$. *European Journal of Combinatorics*, 2021, 91, pp.#103219. 10.1016/j.ejc.2020.103219 . lirmm-03475125

HAL Id: lirmm-03475125

<https://hal-lirmm.ccsd.cnrs.fr/lirmm-03475125>

Submitted on 17 Oct 2022

HAL is a multi-disciplinary open access archive for the deposit and dissemination of scientific research documents, whether they are published or not. The documents may come from teaching and research institutions in France or abroad, or from public or private research centers.

L'archive ouverte pluridisciplinaire **HAL**, est destinée au dépôt et à la diffusion de documents scientifiques de niveau recherche, publiés ou non, émanant des établissements d'enseignement et de recherche français ou étrangers, des laboratoires publics ou privés.



Distributed under a Creative Commons Attribution - NonCommercial| 4.0 International License

r -hued $(r + 1)$ -coloring of planar graphs with girth at least 8 for $r \geq 9$

Hoang La^a, Mickael Montassier^a, Alexandre Pinlou^a, Petru Valicov^{a,b}

^aLIRMM, Université de Montpellier, CNRS, Montpellier, France

^bLIS, Aix-Marseille Université, CNRS, Marseille, France

Abstract

Let $r, k \geq 1$ be two integers. An r -hued k -coloring of the vertices of a graph $G = (V, E)$ is a proper k -coloring of the vertices, such that, for every vertex $v \in V$, the number of colors in its neighborhood is at least $\min\{d_G(v), r\}$, where $d_G(v)$ is the degree of v . We prove the existence of an r -hued $(r + 1)$ -coloring for planar graphs with girth at least 8 for $r \geq 9$. As a corollary, every planar graph with maximum degree $\Delta \geq 9$ and girth at least 8 admits a 2-distance $(\Delta + 1)$ -coloring.

Keywords: planar graphs, 2-distance coloring, r -hued coloring, dynamic coloring, discharging method

1. Introduction

A k -coloring of the vertices of a graph $G = (V, E)$ is a map $\phi : V \rightarrow \{1, 2, \dots, k\}$. A k -coloring ϕ is a *proper coloring*, if and only if, for all edge $xy \in E$, $\phi(x) \neq \phi(y)$. In other words, no two adjacent vertices have the same color. The *chromatic number* of G , denoted $\chi(G)$, is the smallest integer k so that G has a proper k -coloring. A generalization of k -coloring is k -list-coloring. A graph G is *L -list colorable* if for a given list assignment $L = \{L(v) : v \in V(G)\}$ there is a proper coloring ϕ of G such that for all $v \in V(G)$, $\phi(v) \in L(v)$. If G is L -list colorable for every list assignment L with $|L(v)| \geq k$ for all $v \in V(G)$, then G is said to be *k -choosable* or *k -list-colorable*. The *list chromatic number* of a graph G , is the smallest integer k such that G is k -choosable. List coloring can be very different from usual coloring as there exist graphs with a small chromatic number and an arbitrarily large list chromatic number.

In 1969, Kramer and Kramer introduced the notion of 2-distance coloring [28, 29]. This notion generalizes the “proper” constraint (that does not allow two adjacent vertices to have the same color) in the following way: a *2-distance k -coloring* is such that no pair of vertices at distance at most 2 have the same color (similarly to proper k -list-coloring, one can also define *2-distance k -list-coloring*). The *2-distance chromatic number* of G , denoted $\chi^2(G)$, is the smallest integer k so that G has a 2-distance k -coloring. An example of 2-distance colorings is given in Figure 1.

For all $v \in V$, we denote $d_G(v)$ the degree of v in G and by $\Delta(G) = \max_{v \in V} d_G(v)$ the maximum degree of a graph G . For brevity, when it is clear from the context, we will use Δ (resp. $d(v)$) instead of $\Delta(G)$ (resp. $d_G(v)$). One can observe that, for any graph G , $\Delta + 1 \leq \chi^2(G) \leq \Delta^2 + 1$. The lower bound is trivial since, in a 2-distance coloring, every neighbor of a vertex v with degree Δ , and v itself must have a different color. As for the upper bound, a greedy algorithm shows that $\chi^2(G) \leq \Delta^2 + 1$. Moreover, this bound is tight for some graphs, for example, Moore graphs of

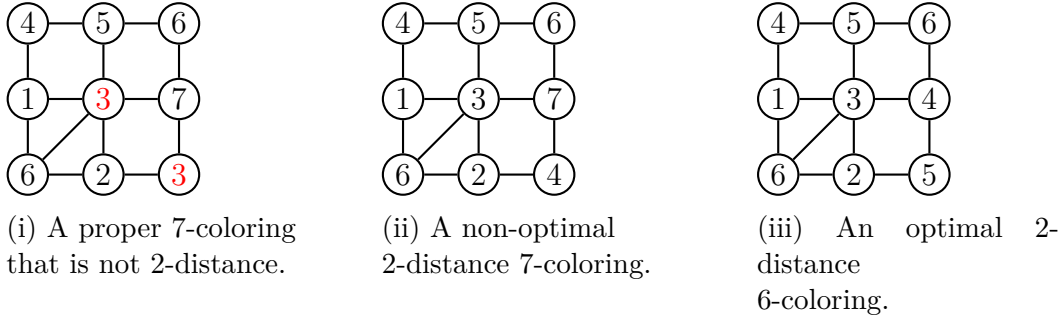

Figure 1: A graph G with $\chi^2(G) = 6$ and $\chi(G) = 3$.

type $(\Delta, 2)$, which are graphs where all vertices have degree Δ , are at distance at most two from each other, and the total number of vertices is $\Delta^2 + 1$. See Figure 2.

A graph is *planar* if one can draw its vertices with points on the plane, and edges with curves intersecting only at its endpoints. When G is a planar graph, Wegner conjectured in 1977 that $\chi^2(G)$ becomes linear in $\Delta(G)$:

Conjecture 1 (Wegner [38]). *Let G be a planar graph with maximum degree Δ . Then,*

$$\chi^2(G) \leq \begin{cases} 7, & \text{if } \Delta \leq 3, \\ \Delta + 5, & \text{if } 4 \leq \Delta \leq 7, \\ \lfloor \frac{3\Delta}{2} \rfloor + 1, & \text{if } \Delta \geq 8. \end{cases}$$

The upper bound for the case where $\Delta \geq 8$ is tight (see Figure 3(i)). Recently, the case $\Delta \leq 3$ was proved by Thomassen [37], and by Hartke *et al.* [22] independently. For $\Delta \geq 8$, Havet *et al.* [23] proved that the bound is $\frac{3}{2}\Delta(1 + o(1))$, where $o(1)$ is as $\Delta \rightarrow \infty$ (this bound holds for 2-distance list-colorings). Conjecture 1 holds for K_4 -minor free graphs [31].

For large Δ (≥ 8), the coefficient before Δ becomes 1 when the graph becomes “sparser”. Here, a “sparse” graph means that it has a “low” number of edges. One way to measure the sparsity of a graph is through its maximum average degree. The *average degree* $\text{ad}(G)$ of a graph $G = (V, E)$ is defined by $\text{ad}(G) = \frac{2|E|}{|V|}$. The *maximum average degree* $\text{mad}(G)$ is the maximum, over all subgraphs H of G , of $\text{ad}(H)$. Another way to measure the sparsity is through the girth, i.e. the length of a shortest cycle. We denote by $g(G)$ the girth of G . Intuitively, the higher the girth of a graph is, the sparser it gets. These two measures can actually be linked directly in the case of planar graphs.

Proposition 2 (Folklore). *For every planar graph G , $(\text{mad}(G) - 2)(g(G) - 2) < 4$.*

As a consequence, any theorem with an upper bound on $\text{mad}(G)$ can be translated to a theorem with a lower bound on $g(G)$ under the condition that G is planar.

In the case of sparse planar graphs, extensive researches have been done and many results have taken the following form: *every planar graph G of girth $g \geq g_0$ and $\Delta(G) \geq \Delta_0$ satisfies $\chi^2(G) \leq \Delta + c(g_0, \Delta_0)$, where $c(g_0, \Delta_0)$ is a constant depending only on g_0 and Δ_0 .* Table 1 shows all known such results on the 2-distance chromatic number of planar graphs with fixed girth, up to our own knowledge.

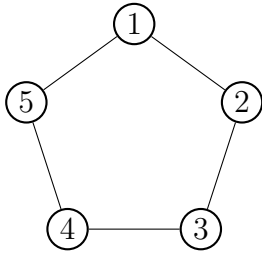

(i) The Moore graph of type (2,2): the odd cycle C_5

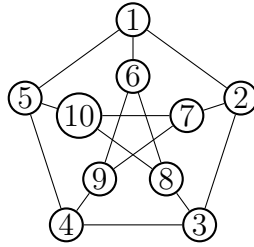

(ii) The Moore graph of type (3,2): the Petersen graph.

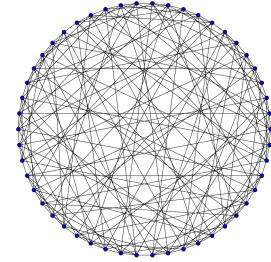

(iii) The Moore graph of type (7,2): the Hoffman-Singleton graph.

Figure 2: Examples of Moore graphs for which $\chi^2 = \Delta^2 + 1$.

$\lfloor \frac{\Delta}{2} \rfloor - 1$ vertices $\lceil \frac{\Delta}{2} \rceil$ vertices

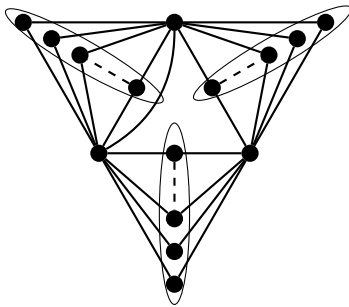

$\lfloor \frac{\Delta}{2} \rfloor$ vertices

(i) A graph with girth 3 and $\chi^2 = \lfloor \frac{3\Delta}{2} \rfloor + 1$

$\lfloor \frac{\Delta}{2} \rfloor - 1$ vertices $\lceil \frac{\Delta}{2} \rceil$ vertices

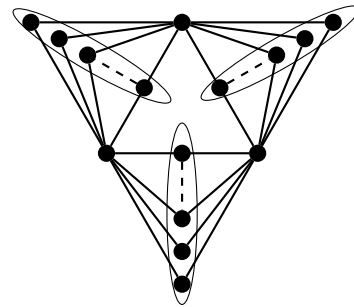

$\lfloor \frac{\Delta}{2} \rfloor$ vertices

(ii) A graph with girth 4 and $\chi^2 = \lfloor \frac{3\Delta}{2} \rfloor - 1$.

Figure 3: Graphs with $\chi^2 \approx \frac{3}{2}\Delta$

$\chi^2(G)$ g_0	$\Delta + 1$	$\Delta + 2$	$\Delta + 3$	$\Delta + 4$	$\Delta + 5$	$\Delta + 6$	$\Delta + 7$	$\Delta + 8$
3				$\Delta = 3$ [37, 22]				
4								
5		$\Delta \geq 10^7$ [3] ²	$\Delta \geq 339$ [20]	$\Delta \geq 312$ [19]	$\Delta \geq 15$ [11] ¹	$\Delta \geq 12$ [10] ²	$\Delta \neq 7, 8$ [19]	all Δ [18]
6		$\Delta \geq 17$ [5] ³	$\Delta \geq 9$ [10] ²		all Δ [13]			
7	$\Delta \geq 16$ [24] ²			$\Delta = 4$ [16] ³				
8	$\Delta \geq 10$ [24] ² $\Delta \geq 9^4$		$\Delta = 5$ [9] ³					
9	$\Delta \geq 8$ [4] ⁵	$\Delta = 5$ [9] ³	$\Delta = 3$ [17] ²					
10	$\Delta \geq 6$ [24] ²							
11		$\Delta = 4$ [16] ³						
12	$\Delta = 5$ [24] ²	$\Delta = 3$ [7] ²						
13								
14	$\Delta \geq 4$ [4] ⁵							
...								
22	$\Delta = 3$ [24] ²							

Table 1: The latest results with a coefficient 1 before Δ in the upper bound of χ^2 .

For example, the result from line “7” and column “ $\Delta + 1$ ” from Table 1 reads as follows : “every planar graph G of girth at least 7 and of Δ at least 16 satisfies $\chi^2(G) \leq \Delta + 1$ ”. The crossed out cases in the first column correspond to the fact that, for $g_0 \leq 6$, there are planar graphs G with $\chi^2(G) = \Delta + 2$ for arbitrarily large Δ [6, 21]. The lack of results for $g \geq 4$ is due to the fact that the graph in Figure 3(ii) has girth 4, and $\chi^2 = \lfloor \frac{3\Delta}{2} \rfloor - 1$ for all Δ . Finally, many of these results are corollaries of theorems on 2-distance list-colorings or 2-distance colorings of graphs with bounded maximum average degree.

The “2-distance” condition in 2-distance colorings requires that vertices at distance at most two have different colors. In other words, all neighbors of the same vertex must have different colors. This condition was generalized recently and the notion of r -hued coloring was introduced [33]. Let $r, k \geq 1$ be two integers. An r -hued k -coloring of the vertices of G is a proper k -coloring of the vertices, such that all vertices are r -hued. A vertex is r -hued if the number of colors in its neighborhood $N_G(v) = \{x | xv \in E\}$ is at least $\min\{d_G(v), r\}$. The r -hued chromatic number of G , denoted $\chi_r(G)$, is the smallest integer k so that G has an r -hued k -coloring.

It is indeed a generalization of 2-distance colorings which corresponds to the case $r \geq \Delta$, as all vertices in the same neighborhood will have different colors. More generally, its link to proper coloring and 2-distance coloring resides in the following equation:

$$\chi(G) = \chi_1(G) \leq \chi_2(G) \leq \dots \leq \chi_\Delta(G) = \chi_{\Delta+1}(G) = \dots = \chi^2(G) \quad (1)$$

Examples of r -hued colorings are given in Figure 4.

¹Corollaries of r -hued list-colorings of planar graphs.

²Corollaries of 2-distance list-colorings of planar graphs.

³Corollaries of 2-distance list-colorings of graphs with a bounded maximum average degree.

⁴This is a corollary of our result (see Corollary 5).

⁵Corollaries of 2-distance colorings of graphs with a bounded maximum average degree.

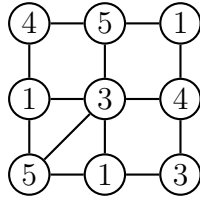

(i) A 2-hued 5-coloring which is not a 2-distance coloring

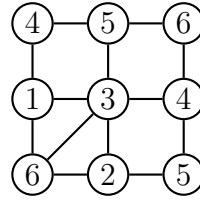

(ii) A 5-hued 6-coloring which is also a 2-distance coloring

Figure 4: A graph G with $\Delta = 5$.

Similar to the 2-distance chromatic number, the r -hued chromatic number is linear in r when it comes to planar graphs. In 2014, Song *et al.* proposed a generalization of Conjecture 1:

Conjecture 3 (Song *et al.* [34]). *Let G be a planar graph. Then,*

$$\chi_r(G) \leq \begin{cases} r + 3, & \text{if } 1 \leq r \leq 2, \\ r + 5, & \text{if } 3 \leq r \leq 7, \\ \lfloor \frac{3r}{2} \rfloor + 1, & \text{if } r \geq 8. \end{cases}$$

One can note that the case $r = 1$ corresponds to the Four Color Theorem [1, 2]; additionally, by taking $r = \Delta(G)$, Conjecture 3 implies Conjecture 1 except for the case $r = 3$. Moreover, the only extremal known examples reaching the upper bounds of Conjecture 3 are the same as for Conjecture 1 (see Figure 3(i)).

The case of $r = 2$ has been proven by Chen *et al.* in [14]. Song and Lai [35] proved that, if $r \geq 8$, then every planar graph verifies $\chi_r(G) \leq 2r + 16$. Similar to 2-distance coloring, the coefficient before r in this upper bound becomes 1 for graphs with a higher girth. Table 2 shows all known results of the following form: *let r and r_0 be integers such that $r \geq r_0$, every planar graph G of girth $g(G) \geq g_0$ satisfies $\chi_r(G) \leq r + c(g_0, r_0)$, where $c(g_0, r_0)$ is a constant depending only on g_0 and r_0 .*

$\chi_r(G)$ \ g_0	$r + 1$	$r + 2$	$r + 3$	$r + 4$	$r + 5$	$r + 6$	$r + 7$...	$r + 10$
3		$r = 2$ [25] ⁶	$r = 2$ [14]	$r = 2$ [27] ⁷			$r = 3$ [32]		
4									
5					$r \geq 15$ [11] ⁸				all r [11]
6					$r \geq 3$ [30]				
7		$r = 2$ [27] ⁷		$r = 3$ [26] ⁷					
8	$r \geq 66$ [36] ⁹ $r \geq 9$ ¹⁰								
9	$r \geq 8$ [12] ⁷		$r = 3$ [26] ⁷						
10	$r \geq 6$ [12] ⁷								
11									
12	$r \geq 5$ [12] ⁷								
13									
14		$r = 3$ [15]							

Table 2: The latest results with a coefficient 1 before r in the upper bound of χ_r .

The result from the “9” line and “ $r + 1$ ” column reads “for $r \geq 8$, every planar graph G of girth at least 9 satisfies $\chi_r(G) \leq r + 1$ ”. Since an r -hued coloring is a 2-distance coloring when $r \geq \Delta$, some results for 2-distance colorings come from r -hued colorings. Similarly to 2-distance colorings, many of these results also come from r -hued list-colorings, or r -hued colorings of graphs with a bounded maximum average degree.

We are interested in the case $\chi_r(G) = r + 1$ (as $r + 1$ is a trivial lower bound for $\chi_r(G)$ as soon as the graph contains a vertex of degree at least r). In particular, we were looking for the smallest integer r such that a planar graph of girth at least 8 can be r -hued colored with $r + 1$ colors, with the aim to find a sufficiently good lower bound to obtain a new result on 2-distance coloring which is a long-standing active research area. Song *et al.* [36] showed that every graph G with $\text{mad}(G) < \frac{14}{5} - \epsilon$ and $r \geq f(\epsilon)$ satisfies $\chi_r(G) \leq r + 1$ for $0 < \epsilon \leq \frac{1}{20}$ and $f(\epsilon) = \frac{16}{5\epsilon} + 2$. Therefore, as a corollary, one can derive that, if G is a planar graph with girth at least 8 and $r \geq 66$, then $\chi_r(G) \leq r + 1$. While restricting the study on planar graphs we improve this corollary in Theorem 4.

Our main result is the following:

Theorem 4. *If G is a planar graph with $g(G) \geq 8$, then $\chi_r(G) \leq r + 1$ for $r \geq 9$.*

Hence for $r = \Delta$, we get the following corollary:

Corollary 5. *If G is a planar graph with $g(G) \geq 8$ and $\Delta(G) \geq 9$, then $\chi^2(G) = \Delta(G) + 1$.*

Corollary 5 is an improvement of the best known 2-distance coloring result for planar graphs of girth at least 8 with $\Delta + 1$ colors (see Table 1). Results for this class of graphs were first proved by Borodin *et al.* in [8] who showed that these graphs can be list 2-distance colored with $\Delta + 1$ colors for $\Delta \geq 15$. Later, the lower bound on Δ was improved to $\Delta \geq 10$ by Ivanova in [24]. We generalized these results to r -hued coloring. By dropping the choosability restriction and by exploiting heavily the planarity of the input graph, we are able to improve the lower bound on the maximum degree to $\Delta \geq 9$ for every planar graph of girth at least 8.

Notations and drawing conventions. In the following, we will only consider planar graphs. Each considered planar graph will be embedded into the plane. We will denote $F(G)$ the set of faces of a plane graph G . We denote $d_G(f)$ the size of face $f \in F(G)$. For $v \in V(G)$, the 2-distance neighborhood of v , denoted $N_G^*(v)$, is the set of 2-distance neighbors of v , which are vertices at distance at most two from v , not including v . We also denote $d_G^*(v) = |N_G^*(v)|$. From now on, we will omit the subscript G when there is no ambiguity.

Some more notations:

- A d -vertex (d^+ -vertex, d^- -vertex) is a vertex of degree d (at least d , at most d). A $(d \leftrightarrow e)$ -vertex is a vertex with degree between d and e included.
- A d -face (d^+ -face, d^- -face) is a face of size d (at least d , at most d).

⁶For G connected and different from C_5 .

⁷Corollaries of results on r -hued list-colorings of graphs with a bounded maximum average degree.

⁸Corollaries of results on r -hued list-colorings of planar graphs.

⁹Corollaries of results on r -hued coloring of graphs with a bounded maximum average degree.

¹⁰This is our result (see Theorem 4).

- A k -path (k^+ -path, k^- -path) is a path of length $k + 1$ (at least $k + 1$, at most $k + 1$) where the k internal vertices are 2-vertices.
- A (k_1, k_2, \dots, k_d) -vertex is a d -vertex incident to d different paths, where the i^{th} path is a k_i -path for all $1 \leq i \leq d$.

As a drawing convention for the rest of the figures, black vertices will have a fixed degree, which is represented, and white vertices may have a higher degree than what is drawn.

2. Proof of Theorem 4

Let us now consider the proof of our main result, namely, if G is a planar graph with $g(G) \geq 8$, then $\chi_r(G) \leq r + 1$ for $r \geq 9$.

Let G be a counterexample to Theorem 4 with the fewest number of edges. The purpose of the proof is to prove that G cannot exist. In the following we will study the structural properties of G (Section 2.1). We will then apply a discharging procedure (Section 2.2). For a plane graph $G = (V, E, F)$, Euler's formula $|V| - |E| + |F| = 2$ can be rewritten as

$$\sum_{v \in V(G)} (3d_G(v) - 8) + \sum_{f \in F(G)} (d_G(f) - 8) = -16. \quad (2)$$

We assign to each vertex v the charge $\mu(v) = 3d(v) - 8$ and to each face f the charge $\mu(f) = d(f) - 8$. To prove the non-existence of G , we will redistribute the charges preserving their sum and obtaining a non-negative total charge, which will contradict Equation (2).

2.1. Structural properties of G

Without loss of generality, we can assume that G is connected. Moreover G has no vertex of degree 1. Otherwise, we can simply remove the unique edge incident to such vertex v and color the resulting graph with an r -hued coloring ϕ , which is possible due to the minimality of $|E(G)|$. Then, we add the edge back and check the degree of v 's unique neighbor x in G . If $d(x) \leq r$, we can choose a color for v different from x 's and all of its neighbors' to maintain the r -hued property of the coloring. If $d(x) > r$, then x is already r -hued, so it suffices to choose a color for v different from $\phi(x)$.

Lemma 6. *Let w be a vertex of G that is adjacent to k vertices u_i ($k \leq d(w)$), each satisfying $d_G^*(u_i) \leq r + i - 1$ for $1 \leq i \leq k$. Then we have $d_G^*(w) \geq r + k + 1$.*

Proof. Suppose by contradiction that w is adjacent to u_i with $d_G^*(u_i) \leq r + i - 1$ for $1 \leq i \leq k$, but $d_G^*(w) \leq r + k$. See Figure 5. We remove the edges wu_i for $1 \leq i \leq k$. By minimality of G , let ϕ_H be a r -hued coloring of $H = (V, E \setminus \{wu_1, \dots, wu_k\})$.

We uncolor the vertex w and the vertices u_i for $1 \leq i \leq k$. We extend then ϕ to G as follows :

1. We define $\phi_G(v) = \phi_H(v)$ for all $v \in V \setminus \{w, u_1, \dots, u_k\}$.

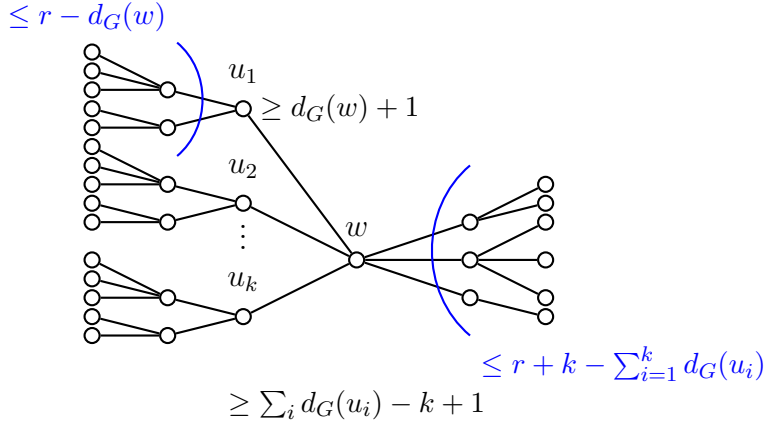

Figure 5: The configuration of Lemma 6.

2. We define $\phi_G(w)$ to be a color different from all of those of the vertices of $F_w = \bigcup_{i=1}^k N_G(u_i) \setminus \{w\} \cup N_H^*(w)$. Since G has girth at least 8, we have $|F_w| = \sum_{i=1}^k (d_G(u_i) - 1) + d_H^*(w) = \sum_{i=1}^k (d_G(u_i) - 1) + d_G^*(w) - \sum_{i=1}^k d_G(u_i) = d_G^*(w) - k$. By hypothesis, we have $d_G^*(w) \leq r + k$ and thus $|F_w| \leq r$. Thus, we have $r + 1$ colors and at most r are forbidden, so it remains at least one color for w .
3. We then define $\phi_G(u_k)$ to be a color different from those that appear on $F_{u_k} = N_H^*(u_k) \cup N_H(w) \cup \{w\}$. Since $d_G^*(u_i) \leq r + i - 1$, we have $d_H^*(u_i) \leq r + i - 1 - d_G(w)$. Therefore, we have $|F_{u_k}| = d_H^*(u_k) + d_H(w) + 1 \leq (r + k - 1 - d_G(w)) + d_H(w) + 1 = (r + k - 1 - d_G(w)) + (d_G(w) - k) + 1 = r$. So it remains at least one color for u_k .
4. One by one (from $k - 1$ to 1), we define $\phi_G(u_i)$ to be a color different from those that appear on $F_{u_i} = N_H^*(u_i) \cup N_H(w) \cup \{w, u_{i+1}, u_{i+2}, \dots, u_k\}$. Using similar argument as the previous subcase, $|F_{u_i}| \leq r$ and thus it remains at least one color for each u_i .

Observe that we 2-distance colored the vertices w, u_1, \dots, u_k . Hence the obtained coloring ϕ_G is r -hued. \square

Lemma 7. *Graph G has no 4^+ -paths.*

Proof. Suppose G contains a 4-path $stuvwx$ (see Figure 6). Then $d^*(u) = d^*(v) = 4 < r$ which contradicts Lemma 6. \square

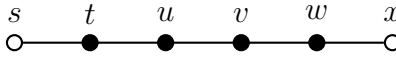

Figure 6: A 4-path.

Lemma 8. *Both endvertices of a 3-path have degree r .*

Proof. Suppose that G contains a 3-path $stuvw$ (see Figure 7). Since $d^*(u) = 4 \leq r$, we have $d^*(v) \geq r + 2$ due to Lemma 6. Moreover, $d^*(v) = d(w) + 2$, so $d(w) \geq r$. Suppose now that $d(w) > r$. Let ϕ be an r -hued coloring of $G' = G - \{u, v\}$ (by minimality of G). Whatever color we choose for v , vertex w is r -hued since $|\phi(N_{G'}(w))| \geq \min(d_G(w) - 1, r) \geq r = \min(d_G(w), r)$. It suffices to choose $\phi(v)$ different from $\phi(w)$ (to have a proper coloring) and from $\phi(t)$ (to make sure

that u is r -hued). Finally, we 2-distance color u (the obtained coloring is proper, and the vertices t and v are also r -hued). \square

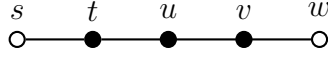

Figure 7: A 3-path.

Lemma 9. *At least one of the endvertices of a 2-path has degree r or both of them have degree $r - 1$.*

Proof. Consider a 2-path $uxyw$ (see Figure 8). Suppose by contradiction that $d(w) \neq r$ and $d(u) \notin \{r - 1, r\}$.

If $d(u) \leq r - 2$, then $d^*(x) = d(u) + 2 \leq r$. So, by Lemma 6, $d^*(y) = d(w) + 2 \geq r + 2$ meaning that $d(w) > r$. By minimality of G , we color $G - \{x, y\}$. Observe that w is already r -hued. We 2-distance color x (u and y become r -hued), and we color y with a color different from that of u , x , and w (x becomes r -hued).

If $d(u) \geq r + 1$, then we color $G - \{x, y\}$. Observe that u is r -hued. Either $d(w) \geq r + 1$ (in that case w is already r -hued) and we color y with a color different from that of w and u , or $d(w) \leq r - 1$ and we 2-distance color y . Finally we color x with a color different from the colors of u , y , and w . \square

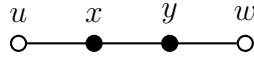

Figure 8: A 2-path.

Lemma 10. *Graph G has no cycles consisting of 3-paths.*

Proof. Suppose that G contains a cycle consisting of k 3-paths (see Figure 9). We remove all vertices $v_{4i+1}, v_{4i+2}, v_{4i+3}$ for $0 \leq i \leq k - 1$. Consider a coloring of the resulting graph. We color $v_1, v_3, v_5, \dots, v_{4k-1}$. This is possible since each of them has at least two choices of color (as $d(v_0) = d(v_4) = \dots = d(v_{4(k-1)}) = r$ due to Lemma 8) and by 2-choosability of even cycles. This procedure ensures that every vertex with even index is r -hued. Finally, it is easy to color greedily $v_2, v_6, \dots, v_{4k-2}$ since they each have at most four forbidden colors (ensuring that every vertex with odd index is r -hued). \square

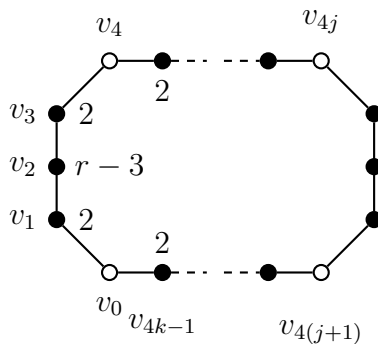

Figure 9: A cycle consisting of consecutive 3-paths.

Lemma 11. *Let v be a vertex such that $3 \leq d(v) \leq \lfloor \frac{r+1}{2} \rfloor$. Then v cannot be a $(2, 1^+, 1^+, \dots, 1^+)$ -vertex.*

Proof. Suppose that G contains a vertex v with $3 \leq d(v) \leq \lfloor \frac{r+1}{2} \rfloor$ that is a $(2, 1^+, 1^+, \dots, 1^+)$ -vertex. Let w be a neighbor of v that belongs to a 2-path. See Figure 10. We have $d^*(w) = d(v) + 2$ and $d^*(v) = 2d(v)$. Moreover, as $d(v) \leq \lfloor \frac{r+1}{2} \rfloor$, it follows that $d^*(w) \leq r$ since $r > 3$. Thus, $d^*(v) \geq r + 2$ by Lemma 6. Since $d(v)$ is an integer and $2d(v) \geq r + 2$, $d(v) \geq \lceil \frac{r+2}{2} \rceil$ which contradicts $d(v) \leq \lfloor \frac{r+1}{2} \rfloor$. \square

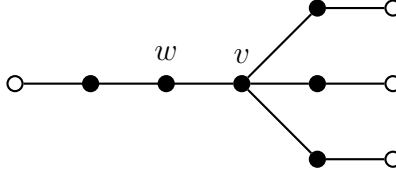

Figure 10: A $(2, 1^+, \dots, 1^+)$ -vertex v with $3 \leq d(v) \leq \lfloor \frac{r+1}{2} \rfloor$.

Lemma 12. *Graph G does not contain the configurations depicted by Figure 11.*

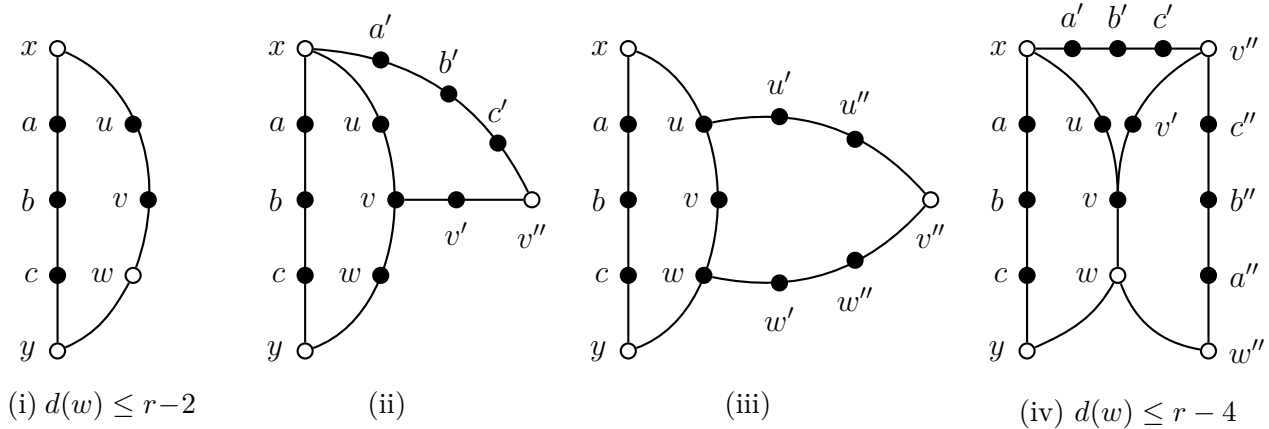

Figure 11: Configurations of Lemma 12.

Proof. Recall that the endvertex of a 3-path always have degree r by Lemma 8. Also, at least one endvertex of a 2-path has degree r unless they both have degree $r - 1$ by Lemma 9. Thus, x , y , and v'' always have degree r in what follows ($r \geq 9$).

(a) Consider the configuration depicted on Figure 11(i) where $d(w) \leq r - 2$.

By minimality of G , let ϕ be an r -hued coloring of $G' = G - \{a, b, u, v\}$. Let us start coloring a and u . Both vertices have $r - 2 + 1 = r - 1$ restrictions coming from x . Additionally, a (resp. u) has one restriction from c (resp. w). As $\phi(c) \neq \phi(w)$ (since $d(y) = r$), one can color a and u with two distinct colors. Finally, b and v can always be 2-distance colored since b only has four restrictions on its number of colors, and v always has at least one choice of color as $d(w) \leq r - 2$. The obtained coloring is r -hued. That contradiction completes the proof.

(b) Consider the configuration depicted on Figure 11(ii).

By minimality of G , let ϕ be an r -hued coloring of $G' = G - \{a, b, c, u, v, w, a', b', c', v'\}$. Observe first that, since $d^*(b) < r + 1$, $d^*(v) < r + 1$, $d^*(b') < r + 1$, vertices b, v, b' can be 2-distance

colored at the end. Vertices a, u, a' have the same $r - 2$ restrictions coming from x ; they must be colored with the last three available colors, say $\alpha_1, \alpha_2, \alpha_3$. Similarly c and w (resp. c' and v') have the same $r - 1$ restrictions coming from y (resp. v''); they must be colored with the last two available colors, say β_1 and β_2 (resp. γ_1 and γ_2). Now, if β_1 does not occur in $\{\alpha_1, \alpha_2, \alpha_3\}$, then one can sequentially color c with β_1 , then w, v', u, c', a' , and a . So by symmetry, we have $\{\beta_1, \beta_2\} \subset \{\alpha_1, \alpha_2, \alpha_3\}$ and $\{\gamma_1, \gamma_2\} \subset \{\alpha_1, \alpha_2, \alpha_3\}$. It follows that $\{\beta_1, \beta_2\}$ and $\{\gamma_1, \gamma_2\}$ have at least one common element, say $\beta_1 = \gamma_1$. Hence we color the vertices as follows: c with β_1 , w with β_2 , v' with $\gamma_1 = \beta_1$, c' with γ_2 (which may be equal to β_2), a' with β_1 , a with β_2 , and u with the color of $\{\alpha_1, \alpha_2, \alpha_3\} \setminus \{\beta_1, \beta_2\}$. That leads to an r -hued coloring of G , a contradiction.

(c) Consider the configuration depicted on Figure 11(iii).

By minimality of G , let ϕ be an r -hued coloring of $G' = G - \{a, b, c\}$. Since $d^*(b) < r + 1$, $d^*(v) < r + 1$, $d^*(u') < r + 1$, $d^*(w') < r + 1$, b can be 2-distance colored and the vertices v, u', w' can be 2-distance recolored at the end if necessary. Vertex a (resp. c) has r restrictions coming from x and u (resp. y and w). If they can be colored differently, then we obtain an r -hued coloring of G . So, they must have the same available color left, say α . Without loss of generality, say $\phi(u) = \beta$ and $\phi(w) = \gamma$. Since ϕ is r -hued, α, β, γ are all distinct. Moreover at least one of u'' and w'' has a color distinct from α ; by symmetry say $\phi(u'') \neq \alpha$. We now recolor u with α , we color a with β , c with α , we 2-distance color b and as well u', v, w' if necessary. That leads to an r -hued coloring of G , a contradiction.

(d) Consider the configuration depicted on Figure 11(iv) where $d(w) \leq r - 4$.

By minimality of G , let ϕ be an r -hued coloring of $G' = G - \{a', b', c'\}$. Recall that $d(w) \leq r - 4$; so $d^*(v) < r + 1$. The same holds for $d^*(b)$ and $d^*(b')$, so vertices v, b, b' can be 2-distance recolored at the end. Vertex a' (resp. c') has r restrictions coming from x, a, u (resp. v'', v', c''). If a' and c' can be colored differently, then we can obtain an r -hued coloring of G . So, they must have the same available color left, say α . Let β be the color of u and γ the one of a . Since ϕ is r -hued, α, β, γ are all distinct. If $\phi(c) \neq \alpha$, then we recolor a with α , a' with γ , and c' with α . It follows that $\phi(c) = \alpha$. Now observe that, as $d(y) = d(v'') = r$, we have $\phi(w) \neq \alpha$ and $\phi(v') \neq \alpha$ (as α is the available color for c'). So we recolor u with α ; we color a' with β and c' with α . It remains to 2-distance recolor v if necessary and to 2-distance color b' . That leads to an r -hued coloring of G , a contradiction.

□

Lemma 13. *Given a $(2, 1, 0)$ -vertex v having a 7-neighbor, the endvertex of the 1-path (distinct from v) is a 8^+ -vertex.*

Proof. Suppose G contains a $(2, 1, 0)$ -vertex v having three neighbors a, b, c such that a belongs to a 2-path, b belong to a 1-path vbd , and such that c has degree 7 and d has degree at most 7. See Figure 12. Let ϕ be an r -hued coloring of $G' = G - \{a, b, v\}$. Let us sequentially 2-distance color v, b , and a . The obtained coloring is r -hued, a contradiction. □

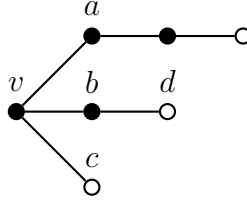

Figure 12: A $(2, 1, 0)$ -vertex having a 7-neighbor.

2.2. Discharging rules

In this section, we define the discharging procedure that contradicts the structural properties of G (see Lemmas 6 to 13) showing that G does not exist.

Definition 14 (Small, medium, and large 2-vertex). A 2-vertex v is said to be

- large if it is adjacent to two 3^+ -vertices,
- medium if it is adjacent to exactly one 2-vertex,
- small if it is adjacent to two 2-vertices.

Definition 15 (Bridge vertex). A large 2-vertex is called a bridge if it has a 3-neighbor and a 8^+ -neighbor.

Definition 16 (Sponsor). Consider the set of 3-paths in G . By Lemma 8, the endvertices of every 3-path are r -vertices and by Lemma 10, the graph induced by the edges of all the 3-paths of G is a forest \mathcal{F} . For each tree of \mathcal{F} , we choose an arbitrary root. Each small 2-vertex v is assigned a unique sponsor which is the r -vertex corresponding to the grandson of v . See Figure 13.

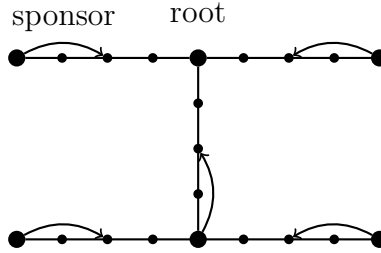

Figure 13: The sponsor assignment in a tree consisting of 3-paths.

Definition 17 (Special and non-special vertices). A $(3 \leftrightarrow 5)$ -vertex is said to be special if it has at least two r -neighbors and non-special otherwise.

We first assign to each vertex v the charge $\mu(v) = 3d(v) - 8$ and to each face f the charge $\mu(f) = d(f) - 8$. By Equation (2), the total sum of the charges is negative. We then apply the following discharging rules (R1 to R9):

Vertices to vertices:

R0 (see Figure 14):

- Every 3^+ -vertex gives 1 to its large 2-neighbors, and 2 to its medium 2-neighbors.
- Every sponsor gives 1 to its small 2-neighbors.

(iii) Every 8^+ -vertex gives 1 to its adjacent bridges.

R1 (see Figure 15):

(i) Every 8^+ -vertex gives 2 to its 3-neighbors.

(ii) Every $(5 \leftrightarrow 7)$ -vertex v gives 1 to its 3-neighbors.

(iii) Every bridge gives 1 to its 3-neighbor.

R2 (see Figure 16):

(i) Every 8^+ -vertex gives 2 to its 4-neighbors.

(ii) Every $(6 \leftrightarrow 7)$ -vertex gives 1 to its 4-neighbors.

R3 (see Figure 17): Every 8^+ -vertex gives 2 to its 5-neighbors.

R4 (see Figure 18): Every special vertex gives 1 to its r -neighbors.

Vertices to faces:

R5 (see Figure 19): Each 8-face $f = v_1v_2 \dots v_8$ with $d(v_1) = d(v_7) = r$, $3 \leq d(v_4) \leq 5$ and $d(v_2) = d(v_3) = d(v_5) = d(v_6) = 2$, receives charge $\frac{1}{2}$ from v_1 and v_7 .

R6 (see Figure 22): Let $f = xabcywvu$ be an 8-face where $abcy$ is a 3-path.

(i) If $xuvw$ is a 2-path with $d(w) \geq r - 1$, then y gives $\frac{1}{2}$ to f .

(ii) If xuv is a 1-path with $d(v) \geq 4$, then x gives $\frac{1}{2}$ to f .

(iii) If xuv is a 1-path with $d(v) = 3$ and $d(w) \leq 5$, then v gives $\frac{1}{2}$ to f .

(iv) If xuv is a 1-path with $d(v) = 3$ and $d(w) \geq 6$, y gives $\frac{1}{2}$ to f .

(v) If $d(u) \geq 6$ and $d(w) \geq 3$, then x gives $\frac{1}{2}$ to f .

(vi) If $4 \leq d(u) \leq 5$ and $d(w) \geq 3$, then u gives $\frac{1}{2}$ to f .

(vii) If $d(u) = 3$ and $d(v) \geq 3$, then u gives $\frac{1}{2}$ to f .

(viii) If u is a $(1, 1, 0)$ -vertex, or a $(1, 0, 0)$ -vertex, with $d(v) = 2$, and $d(w) \geq 3$, then u gives $\frac{1}{2}$ to f .

Faces to faces:

R7 (see Figure 20): Let $f = xabcywvu$ be an 8-face where $abcy$ is a 3-path, and u and w are $(2, 1, 0)$ -vertices (with the 1-path in common). Let u' , u'' , and u''' (resp. w' , w'' , and w''') be, respectively, the 1-distance, 2-distance and 3-distance neighbor of u (resp. w) along its incident 2-path. We also suppose that $u''' \neq w'''$. Let f' be the 9^+ -face incident to $u'''u''u'uvw'w''w'''$. Face f' gives $\frac{1}{2}$ to f .

Faces to vertices:

R8 (see Figure 21): Each face f gives $\frac{1}{2}$ to each of its incident small 2-vertices¹¹.

¹¹ f gives $\frac{1}{2}$ twice to a small 2-vertex if that vertex is only incident to f .

R9 (see Figure 19): Each 8^+ -face f incident to a path $v_1v_2\dots v_7$ as described in **R5** gives 1 to v_4 .

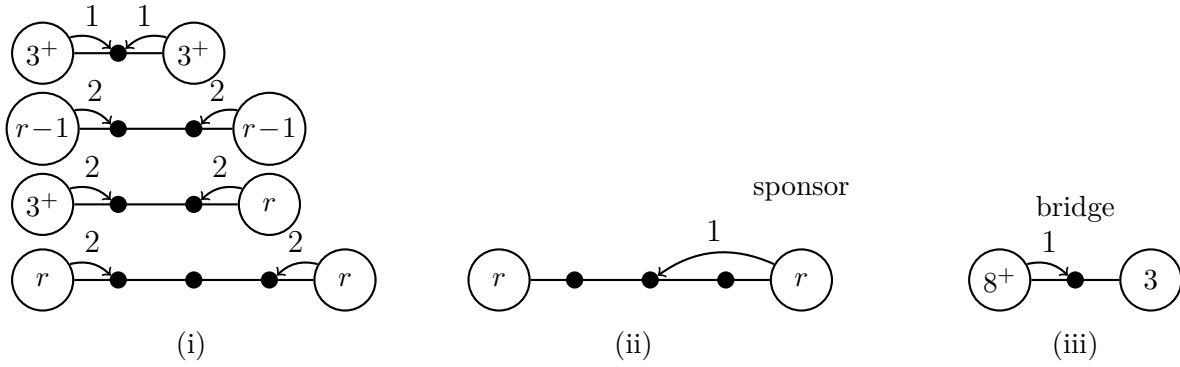

Figure 14: **R0**.

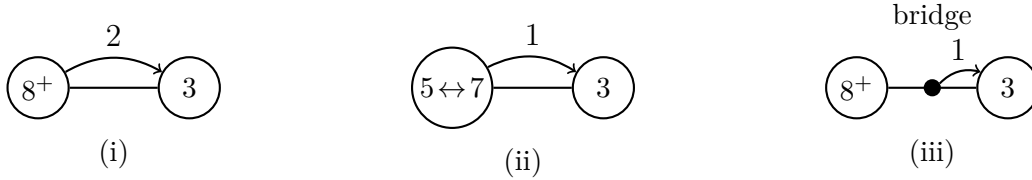

Figure 15: **R1**.

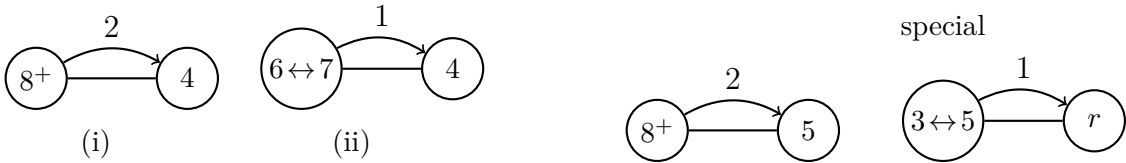

Figure 16: **R2**.

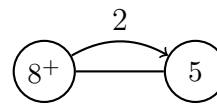

Figure 17: **R3**.

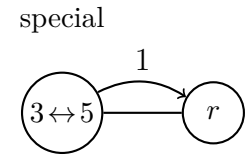

Figure 18: **R4**.

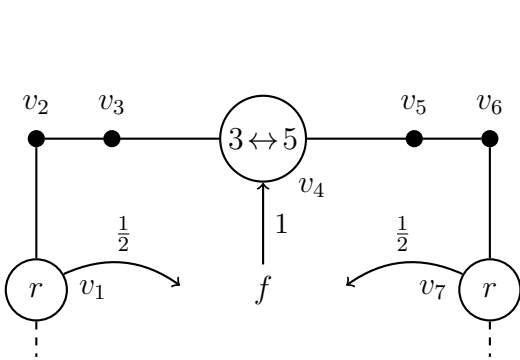

Figure 19: **R5** and **R9**.

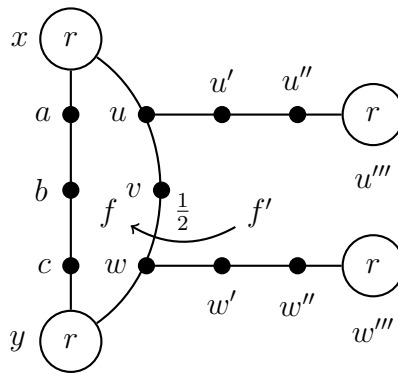

Figure 20: **R7**.

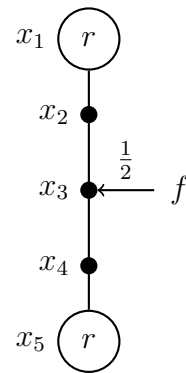

Figure 21: **R8**.

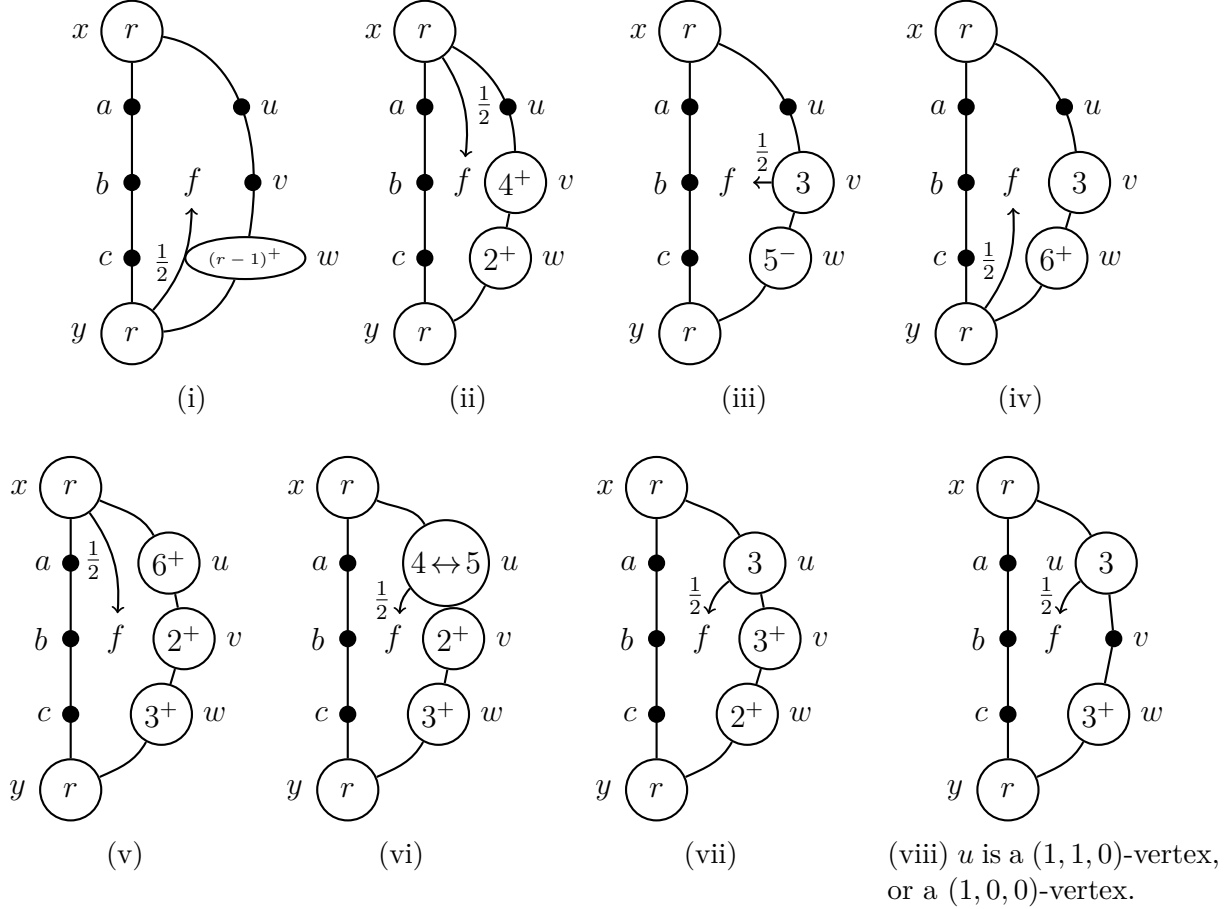

Figure 22: **R6**.

2.3. Verifying that charges on vertices and faces are non-negative

Let μ^* be the assigned charges after the discharging procedure. In what follows, we prove that: $\forall x \in V(G) \cup F(G), \mu^*(x) \geq 0$.

2.3.1. Faces

Let f be a face of G . Recall that $\mu(f) = d(f) - 8$. We consider two cases according to the length of f :

Case 1: $d(f) \geq 9$.

Note that f may give $\frac{1}{2}$ (resp. $\frac{1}{2}, 1$) by **R7** (resp. **R8, R9**). By **R9** (resp. **R8, R7**), face f may give 1 (resp. $\frac{1}{2}, \frac{1}{2}$) at most $\frac{d(f)}{6}$ (resp. $\frac{d(f)}{4}, \frac{d(f)}{8}$) times. Observe that in Figures 19 to 21 except the r -vertices ($u'', w'', x_1, x_5, v_1, v_7$), all other vertices are pairwise distinct. Therefore, assuming that **R9** (resp. **R8, R7**) is applied i (resp. j, k) times, we must have $d(f) \geq 6i + 4j + 8k$.

Observe that: $\mu^*(f) \geq d(f) - 8 - i - \frac{j}{2} - \frac{k}{2} \geq 6i + 4j + 8k - 8 - i - \frac{j}{2} - \frac{k}{2} \geq 5i + \frac{7}{2}j + \frac{15}{2}k - 8 \geq 0$ when $i \geq 2$ or $k \geq 2$ or $j \geq 3$ or ($j \geq 1$ and $i = 1$) or ($j \geq 1$ and $k = 1$) or ($i = 1$ and $k = 1$). Now observe that for the remaining cases: $\mu^*(f) \geq d(f) - 8 - i - \frac{j}{2} - \frac{k}{2} \geq$

$1 - i - \frac{j}{2} - \frac{k}{2} \geq 0$ when $(i, j, k) = (1, 0, 0)$ or $(i, j, k) = (0, 0, 1)$ or $(i, j, k) = (0, 2^-, 0)$. It follows that $\mu^*(f) \geq 0$.

Case 2: $d(f) = 8$.

Suppose f is not incident to a 3-path. It follows that f is involved only in **R5** and **R9**. Observe that if **R9** applies, then **R5** applies. In all cases, we have either $\mu^*(f) \geq d(f) - 8 + 2 \cdot \frac{1}{2} - 1 = 8 - 8 + 1 - 1 = 0$ or $\mu^*(f) \geq \mu(f) \geq 0$.

Suppose that f is incident to a 3-path. By Lemma 10, f has only one such path on its boundaries. Face f gives once $\frac{1}{2}$ by **R8** (and **R9** cannot be applied). We show now that f receives $\frac{1}{2}$ by **R6** or **R7**. Let $f = xabcywvu$ where $abcy$ is a 3-path.

- If f is also incident to a 2-path of the form $xuvw$, then f gets $\frac{1}{2}$ by **R6(i)** (see Figure 22(i)). Note that the case where $d(w) \leq r-2$ does not occur by Lemma 12(i).

$$\mu^*(f) \geq d(f) - 8 - \frac{1}{2} + \frac{1}{2} = 8 - 8 - \frac{1}{2} + \frac{1}{2} = 0.$$

- If f is incident to a 1-path of the form xuv , then f gets $\frac{1}{2}$ by **R6(ii)**, (iii), or (iv) (see Figure 22(ii), (iii), (iv))).

$$\mu^*(f) \geq 0 - \frac{1}{2} + \frac{1}{2} = 0.$$

- If f is incident to a 1-path of the form uvw and $d(u) > 3$, then f gets $\frac{1}{2}$ from **R6(v)** or (vi) (see Figure 22(v), (vi)). If $d(u) = 3$, then u is either a $(1, 1, 0)$ -vertex, or a $(1, 0, 0)$ -vertex, or a $(2, 1, 0)$ -vertex. By symmetry, the same reasoning holds for w . If one of them is a $(1, 1, 0)$ -vertex, or a $(1, 0, 0)$ -vertex, then f gets $\frac{1}{2}$ by **R6(viii)** (see Figure 22(viii)). If both of them are $(2, 1, 0)$ -vertices, then we are in Configuration **R7** (see Figure 20) with $u''' \neq w'''$ by Lemma 12(iii). In that case, f also receives $\frac{1}{2}$. So, we have in all cases:

$$\mu^*(f) \geq 0 - \frac{1}{2} + \frac{1}{2} = 0.$$

- In the remaining case, f receives $\frac{1}{2}$ by **R6(v)**, (vi) or (vii) (see Figure 22(v), (vi), (vii)).

$$\mu^*(f) \geq 0 - \frac{1}{2} + \frac{1}{2} = 0.$$

2.3.2. Vertices

Observation 18. Consider a special $(3 \leftrightarrow 5)$ -vertex u adjacent to an r -vertex v . It follows that **R4** applies, so u gives 1 to v . In return, if $d(u) = 3$ (resp. $d(u) = 4$, $d(u) = 5$), then v gives 2 to u by **R1(i)** (resp. **R2(i)**, **R3**). Additionally, u may give $\frac{1}{2}$ (at most twice) along uv to incident faces by **R6(vi)**, (vii) or (viii) (see Figure 23). To sum up, when **R4** applies, u does not lose charge along uv , as in the worst case $2 - 1 - 2 \cdot \frac{1}{2} = 0$. Moreover, when **R6** does not apply, u gains $2 - 1 = 1$.

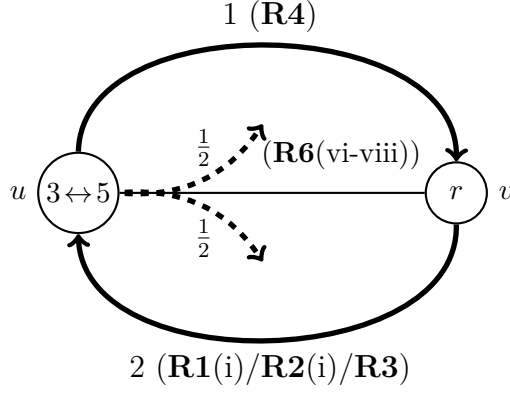

Figure 23: The charge distribution when **R4** applies. Dashed arrows indicate the possible application of **R6**.

Case 1: $d(v) \geq 8$.

Suppose first that $d(v) \neq r$. Observe that v is involved in **R0**(i) and (iii), **R1**(i), **R2**(i), **R3** and v gives at most 2 to each adjacent vertex by **R0**(i), **R1**(i), **R2**(i), **R3** or a combination of **R0**(i) and (iii) (in the case of a bridge). Hence,

$$\mu^*(v) \geq 3d(v) - 8 - 2d(v) = d(v) - 8 \geq 0.$$

Suppose now that $d(v) = r$. Additionally, v also gives charges to faces by **R5** and **R6** and to sponsored small 2-vertices by **R0**(ii). Using the same idea as before, we show that v gives at most 2 along each incident edge.

When **R5** is applied to v , w.l.o.g. $v_1 = v$ in Figure 19, one sends $\frac{1}{2}$ to f via the edge v_1v_8 . The edge v_1v_8 belongs to two faces, hence v_1v_8 may be involved twice by **R5**. If v_8 has degree at least 6, no additional charge transits via v_1v_8 . If v_8 is a $(3 \leftrightarrow 5)$ -vertex, then v_1 gives 2 to v_8 by **R1**(i), **R2**(i), and **R3**, but it receives 1 by **R4** since v_8 would be special as v_1, v_7 are r -vertices. If v_8 has degree 2, then only 1 may transit by **R0**(i). In all cases, at most 2 transits from v_1 along v_1v_8 .

Consider now that **R6** is applied to v . As previously, we show that the charge $\frac{1}{2}$ is given to f via a particular edge on which at most 2 transits. Rule **R6** is applied to v in the cases **R6**(i), **R6**(ii), **R6**(iv), and **R6**(v). Observe that no charge is given to 6^+ -vertices. Hence charge $\frac{1}{2}$ transits (at most twice) along edge yw in **R6**(i) and **R6**(iv), along edge xu in **R6**(v). In case **R6**(ii), charge $\frac{1}{2}$ transits (at most twice) along edge xu and $x = v$ gives 1 to u by **R0**(i). Again at most 2 transits along each incident edge.

Finally, vertex v can sponsor at most one small 2-vertex by the definition of the sponsor relation and **R0**(ii). It follows that:

$$\begin{aligned} \mu^*(v) &\geq 3d(v) - 8 - 2d(v) - 1 \\ &\geq d(v) - 9 = r - 9 \geq 0 \end{aligned}$$

Case 2: $d(v) = 7$.

Observe that v may send 1 by **R1**(ii), **R2**(ii), and **R0**(i) in the case of the 1-path, and may send 2 by **R0**(i) in the case of the 2-path. As $\mu(v) = 13$, $\mu^*(v) \geq 0$ except in the case where

v is incident to seven 2-paths, but in that case $d^*(v) = 14$, contradicting Lemma 6 (that implies $d^*(v) \geq 17$).

Case 3: $d(v) = 6$.

Vertex v may give 1 (resp. 2, 1, 1) by **R0(i)** in the case of the 1-path (resp. **R0(i)** in the case of the 2-path, **R1(ii)**, **R2(ii)**). As $\mu(v) = 10$, $\mu^*(v) \geq 0$ except in the case where v gives 2 to each of five of its neighbors and gives at least 1 to its last neighbor, but in that case $d^*(v) \leq 14$, contradicting Lemma 6 (that implies $d^*(v) \geq 15$).

Case 4: $d(v) = 5$.

Vertex v may give 1 (resp. 2, 1, 1, $\frac{1}{2}$) by **R0(i)** in the case of the 1-path (resp. **R0(i)** in the case of the 2-path, **R1(ii)**, **R4** when it is a special vertex, and **R6(vi)**) and may receive 2 (resp. 1) by **R3(i)** (resp. **R9**). Recall $\mu(v) = 7$.

Suppose that **R6(vi)** is applied to v (v plays the role of u in Figure 22(vi)). Let us use the notations of Figure 22(vi). Hence u gives $\frac{1}{2}$ to f (let say via the edge ux). It may give 1 to x by **R4** (if u is special), and receives 2 from x by **R3**. Moreover **R6(vi)** may be applied to the two faces incident to ux . When we sum the charges transiting along ux , u may give at most $2 \cdot \frac{1}{2} - 2 + 1 = 0$. Hence in the following we consider that, if **R6(vi)** is applied to u , no charge is transferred along ux .

By Lemma 11, v is not a $(2, 1^+, 1^+, 1^+, 1^+)$ -vertex. Hence v is incident to at most four 2-paths. If v is incident to four 2-paths, then v receives 1 from three incident faces by **R9** and may give at most 2, 2, 2, 2, 1 along incident edges ; so $\mu^*(v) \geq 7 + 3 - 4 \cdot 2 - 1 = 1$. If v is incident to exactly three 2-paths, then v receives at least 1 by **R9** and may give at most 2, 2, 2, 1, 1 along incident edges ; so $\mu^*(v) \geq 7 + 1 - 3 \cdot 2 - 2 \cdot 1 = 0$. If v is incident to at most two 2-paths, then $\mu^*(v) \geq 7 - 2 \cdot 2 - 3 \cdot 1 = 0$.

Case 5: $d(v) = 4$.

Vertex v may give 1 (resp. 2, 1, $\frac{1}{2}$) by **R0(i)** in the case of the 1-path (resp. **R0(i)** in the case of the 2-path, **R4**, **R6(vi)**) and may receive 2 (resp. 1, 1) by **R2(i)** (resp. **R2(ii)**, **R9**). Recall $\mu(v) = 4$. Similar to 5-vertices, if **R6(vi)** is applied to v , then no charge is transferred along the edge linking v and the r -vertex. By Lemma 11, v is not a $(2, 1^+, 1^+, 1^+)$ -vertex. Hence, v is incident to at most three 2-paths.

If v is incident to three 2-paths, then v is not special, v receives 1 from two incident faces by **R9** and gives 2, 2, 2, 0 along incident edges ; so $\mu^*(v) = 4 + 2 \cdot 1 - 3 \cdot 2 = 0$.

Suppose now that v is incident to two 2-paths. If v is not incident to a 1-path, then we are done as $\mu^*(v) = 4 - 2 \cdot 2 = 0$ whether v is special or not due to Observation 18. So consider that v is incident to exactly one 1-path by Lemma 11 and so is not special. The 3^+ -neighbor of v has degree at least 6 (otherwise it contradicts Lemma 6, $d^*(v) \leq 11$ while we must have $d^*(v) \geq 12$), then it gives at least 1 to v by **R2** and so $\mu^*(v) \geq 4 + 1 - 2 \cdot 2 - 1 = 0$.

Finally assume that v is incident to at most one 2-path. If v gives at most one along each incident edge, then we are done (as $\mu^*(v) \geq 4 - 4 \cdot 1 \geq 0$). So assume that v gives 2 to one of its neighbors. In that case, it means that **R0(i)** applied and v is thus incident to exactly one 2-path. Since v is not a $(2, 1^+, 1^+, 1^+)$ -vertex, it may be incident to at most two 1-paths. If v is incident to a 2-path and two other 1-paths, then v is not special. Hence we have $\mu^*(v) \geq 4 - 2 - 1 - 1 \geq 0$.

Case 6: $d(v) = 3$.

Vertex v may give 1 (resp. 2, $\frac{1}{2}$, 1) by **R0**(i) in the case of the 1-path (resp. **R0**(i) in the case of the 2-path, **R6**, **R4**) and may receive 2 (resp. 1, 1, 1) by **R1**(i) (resp. **R1**(ii), **R1**(iii), **R9**). Recall $\mu(v) = 1$. By Lemma 11, v is not a $(2, 1^+, 1^+)$ -vertex. Let us examine all possible configurations for v .

- Suppose that v is a $(2, 2, 0)$ -vertex. Let v_1 , v_2 , and u be the two 2-neighbors and 3^+ -neighbor of v respectively. Since v is not special, **R4** does not apply. Vertex v does not fall into any configuration of **R6**, so **R6** does not apply. Vertex v gives 2 to each of its 2-neighbors by **R0**(i). By Lemma 9, the other endvertices of the two 2-paths are r -vertices; so v falls into the configuration in **R9** and receives 1 from an incident face. Moreover, v_1 and v_2 satisfy $d^*(v_i) = 5 \leq r$ ($i = 1, 2$). By Lemma 6, $d^*(v) \geq 12$ and $d^*(v) = d(u) + 4$, so $d(u) \geq 8$. By **R1**(i), v receives 2 from u . In total, we have

$$\mu^*(v) \geq 1 - 2 \cdot 2 + 1 + 2 = 0.$$

- Suppose that v is a $(2, 1, 0)$ -vertex. Let v_1 , v_2 , and u be the two 2-neighbors (where v_1 belongs to the 2-path and v_2 belongs to the 1-path) and 3^+ -neighbor of v respectively. As previously, v is not special. Vertex v_1 has $d^*(v_1) = 5 \leq r$. By Lemma 6, $d^*(v) \geq 11$, and $d^*(v) = d(u) + 4$, so $d(u) \geq 7$. It follows that **R6** does not apply (in particular **R6**(iii)).

If $d(u) \geq 8$, then v receives 2 from u by **R1**(i). Hence, by **R0**(i) and **R1**(i), we have:

$$\mu^*(v) \geq 1 - 2 - 1 + 2 = 0.$$

If $d(u) = 7$, then v receives 1 from u by **R1**(ii). Moreover, the neighbor of v_2 (different from v) has degree at least 8 by Lemma 13. Hence v receives 1 from v_2 by **R1**(iii). It follows that:

$$\mu^*(v) \geq 1 - 2 - 1 + 1 + 1 = 0.$$

- Suppose that v is a $(2, 0, 0)$ -vertex. Let x_1, x_2 be the 0-path neighbors of v and v_1 be the 2-path neighbor of v .

Suppose first that v is not concerned by **R6**(vii) (i.e. v only gives charge to vertices). Vertex v_1 satisfies $d^*(v_1) = 5 \leq r$. By Lemma 6, $d^*(v) \geq r + 2$. Since $d^*(v) = d(x_1) + d(x_2) + 2$, we have $d(x_1) + d(x_2) \geq r \geq 9$. W.l.o.g. x_1 has degree at least 5. Note that, if v is non-special, then **R4** does not apply and v receives at least 1 from x_1 by **R1**(i) or **R1**(ii); if v is special, then $d(x_1) = d(x_2) = r$, v gives 1 to x_1 and x_2 by **R4** and receives 2 from x_1 and x_2 by **R1**(i). In both case, we can consider that v receives at least 1 from x_1 . So

$$\mu^*(v) \geq 1 - 2 + 1 = 0.$$

Suppose now that **R6**(vii) is applied to v . Observe that **R6**(vii) is applied once. If v is non-special, then v receives 2 from its r -neighbor by **R1**(i); if it is special, by the same arguments as in the previous paragraph, we can consider that v receives 1 from both x_1 and x_2 (by **R1**(i) and **R4**). So

$$\mu^*(v) \geq 1 - 2 - \frac{1}{2} + 2 > 0.$$

- Suppose that v is a $(1, 1, 1)$ -vertex. Note that only **R0(i)**, **R1(iii)**, and **R6(iii)** may concern v . Vertex v gives 1 to each 2-neighbor by **R0(i)** and $\frac{1}{2}$ to at most one incident face by **R6(iii)** and Lemma 12(ii). Let vxw be a 1-path incident to v . We have $d^*(v) = 6 \leq r$. It follows that $d^*(x) \geq 11$ by Lemma 6 and as $d^*(x) = d(w) + 3$, we have $d(w) \geq 8$, meaning that **R1(iii)** applies. Thus,

$$\mu^*(v) \geq 1 - 3 \cdot 1 - \frac{1}{2} + 3 \cdot 1 > 0.$$

- Suppose that v is a $(1, 1, 0)$ -vertex. Let vv_1w_1 and vv_2w_2 be the two 1-paths incident to v and let u be the 3^+ -neighbor of v . Note that v is not special, and it may be concerned by **R0(i)**, **R1**, **R6(iii)**, and **R6(viii)**.

Suppose first that v is not concerned by **R6** (i.e. v only gives charge to vertices). By **R0(i)**, v gives 1 to each of its 2-neighbors.

If $d(u) \geq 5$, then we have by **R1(i)** and **R1(ii)**:

$$\mu^*(v) \geq 1 - 2 \cdot 1 + 1 = 0.$$

If $d(u) \leq 4$, then $d^*(v) = 8 \leq r$. By Lemma 6, $d^*(v_1) \geq 11$. As $d^*(v_1) = d(w_1) + 3$, we have $d(w_1) \geq 8$ meaning that v receives 1 from v_1 by **R1(iii)** (and from v_2 by symmetry). Hence,

$$\mu^*(v) \geq 1 - 2 \cdot 1 + 2 \cdot 1 > 0.$$

Suppose that **R6(iii)** or **R6(viii)** is applied to v .

Assume we are in configuration **R6(viii)**. Vertex v gives 1 to each of its 2-neighbors and $\frac{1}{2}$ to at most three incident faces (by a combination of **R6(iii)** and **R6(viii)**), and receives 2 from u by **R1(i)**. If it gives charge to three faces, then w_1 and w_2 are also endvertices of a 3-path, meaning that they are of degree $r \geq 8$. By **R1(iii)**, v receives 1 from each bridge v_1 and v_2 . Thus,

$$\mu^*(v) \geq 1 - 2 \cdot 1 - 3 \cdot \frac{1}{2} + 2 + 2 \cdot 1 > 0.$$

Now, if v only gives charge to at most two faces, then we have:

$$\mu^*(v) \geq 1 - 2 \cdot 1 - 2 \cdot \frac{1}{2} + 2 = 0.$$

Assume we are in configuration **R6(iii)** (only, otherwise we are in the previous case). Let us reuse the notation of Figure 22. Observe that either w has degree 2 and u and w are two bridges (since x and y are r -vertices), or w is a $(3 \leftrightarrow 5)$ -vertex and the endvertices of the 1-paths incident to v (different from v) are 8^+ -vertices by Lemma 6 implying that the 2-neighbors of v are bridges. Hence if **R6(iii)** is applied at most twice, we have by **R0(i)** and **R1(iii)**:

$$\mu^*(v) \geq 1 - 2 \cdot 1 - 2 \cdot \frac{1}{2} + 2 \cdot 1 = 0.$$

Now, if **R6(iii)** is applied three times, then we obtain the configuration depicted by Figure 11(iv) which is forbidden by Lemma 12.

- Suppose that v is a $(1, 0, 0)$ -vertex. Let u , v_1 , and v_2 be its 2-neighbor and the two 3^+ -neighbors of v , respectively. First note that each time **R4** applies, by Observation 18, in the worst case, the total number of charges transferred via vv_1 and vv_2 is 0. So,

$$\mu^*(v) \geq 1 - 1 = 0$$

Suppose now that **R6**(iii), (vii) or (viii) is applied to v (which is not special).

If **R6**(vii) or **R6**(viii) is applied to v , then (at least) one of the 3^+ -neighbors of v is an r -vertex. So v gains 2 by **R1**(i). It follows that

$$\mu^*(v) \geq 1 - 1 - 3 \cdot \frac{1}{2} + 2 > 0.$$

Suppose now only **R6**(iii) is applied to v . Observe that **R6**(iii) may be applied at most twice. Vertex v receives 1 from the bridge by **R1**(iii). Hence,

$$\mu^*(v) \geq 1 - 1 - 2 \cdot \frac{1}{2} + 1 = 0.$$

- Suppose that v is a $(0, 0, 0)$ -vertex. If **R4** is applied (i.e. v is special), then v does not need any charge by Observation 18. Suppose that v is not special. Vertex v may give charge to faces only by **R6**(vii) and in that case it receives 2 from its r -neighbor by **R1**(i). It follows that:

$$\mu^*(v) \geq 1 - 3 \cdot \frac{1}{2} + 2 > 0.$$

Case 7: $d(v) = 2$.

We have $\mu(v) = -2$. Vertex v receives 2 by **R0**(i) unless v is a small 2-vertex. When v is small, it receives 1 from its sponsor by **R0**(ii) and twice $\frac{1}{2}$ from incident faces by **R8**. Now if v is a bridge, then it also gives 1 to a 3-vertex by **R1**(iii), but it also receives 1 from **R0**(iii). In all cases, $\mu^*(v) = 0$.

To sum up, we have proven that we started out with a negative total number of charge, and after the discharging procedure that preserves this sum, we end up with a non-negative one, a contradiction. That completes the proof of Theorem 4.

References

- [1] K. Appel and W. Haken. Every planar map is four colorable. part I. discharging. *Illinois Journal of Mathematics*, 21:429–490, 1977.
- [2] K. Appel, W. Haken, and J. Koch. Every planar map is four colorable. part II. reducibility. *Illinois Journal of Mathematics*, 21:491–567, 1977.
- [3] M. Bonamy, D. Cranston, and L. Postle. Planar graphs of girth at least five are square $(\Delta + 2)$ -choosable. *Journal of Combinatorial Theory, Series B*, 134:218–238, 2019.
- [4] M. Bonamy, B. L ev eque, and A. Pinlou. 2-distance coloring of sparse graphs. *Journal of Graph Theory*, 77(3), 2014.

- [5] M. Bonamy, B. Lévêque, and A. Pinlou. Graphs with maximum degree $\Delta \geq 17$ and maximum average degree less than 3 are list 2-distance $(\Delta + 2)$ -colorable. *Discrete Mathematics*, 317:19–32, 2014.
- [6] O.V. Borodin, A.N. Glebov, A.O. Ivanova, T.K. Neutroeva, and V.A. Tashkinov. Sufficient conditions for the 2-distance $(\Delta + 1)$ -colorability of plane graphs. *Sibirskie Elektronnye Matematicheskie Izvestiya*, 1:129–141, 2004.
- [7] O.V. Borodin and A.O. Ivanova. List 2-facial 5-colorability of plane graphs with girth at least 12. *Discrete Mathematics*, 312:306–314, 2012.
- [8] O.V. Borodin, A.O. Ivanova, and T.K. Neutroeva. List 2-distance $(\Delta + 1)$ -coloring of planar graphs with given girth. *Journal of Applied and Industrial Mathematics*, 2:317–328, 2008.
- [9] Y. Bu, X. Lv, and X. Yan. The list 2-distance coloring of a graph with $\Delta(G) = 5$. *Discrete Mathematics, Algorithms and Applications*, 7(2):1550017, 2015.
- [10] Y. Bu and C. Shang. List 2-distance coloring of planar graphs without short cycles. *Discrete Mathematics, Algorithms and Applications*, 8(1):1650013, 2016.
- [11] Y. Bu and J. Zhu. *Channel Assignment with r -Dynamic Coloring: 12th International Conference, AAIM 2018, Dallas, TX, USA, December 3–4, 2018, Proceedings*, pages 36–48. 2018.
- [12] Y. Bu and J. Zhu. List r -dynamic coloring of graphs with small maximum average degree. *Discrete Applied Mathematics*, 258:254–263, 2019.
- [13] Y. Bu and X. Zhu. An optimal square coloring of planar graphs. *Journal of Combinatorial Optimization*, 24:580–592, 2012.
- [14] Y. Chen, S. Fan, H.-J. Lai, H. Song, and L. Sun. On dynamic coloring for planar graphs of higher genus. *Discrete Applied Mathematics*, 160:1064–1071, 2012.
- [15] J. Cheng, H.-J. Lai, K.J. Lorenzen, R. Luo, J.C. Thompson, and C.-Q. Zhang. r -hued coloring of sparse graphs. *Discrete Applied Mathematics*, 237:75–81, 2018.
- [16] D. Cranston, R. Eрман, and R. Škrekovski. Choosability of the square of a planar graph with maximum degree four. *Australian Journal of Combinatorics*, 59(1):86–97, 2014.
- [17] D. Cranston and S.-J. Kim. List-coloring the square of a subcubic graph. *Journal of Graph Theory*, 1:65–87, 2008.
- [18] W. Dong and W. Lin. An improved bound on 2-distance coloring plane graphs with girth 5. *Journal of Combinatorial Optimization*, 32(2):645–655, 2016.
- [19] W. Dong and W. Lin. On 2-distance coloring of plane graphs with girth 5. *Discrete Applied Mathematics*, 217:495–505, 2017.
- [20] W. Dong and B. Xu. 2-distance coloring of planar graphs with girth 5. *Journal of Combinatorial Optimization*, 34:1302–1322, 2017.
- [21] Z. Dvořák, D. Král, P. Nejedlý, and R. Škrekovski. Coloring squares of planar graphs with girth six. *European Journal of Combinatorics*, 29(4):838–849, 2008.

- [22] S.G. Hartke, S. Jahanbekam, and B. Thomas. The chromatic number of the square of subcubic planar graphs. arXiv:1604.06504, 2018.
- [23] F. Havet, J. Van Den Heuvel, C. McDiarmid, and B. Reed. List colouring squares of planar graphs. arXiv:0807.3233, 2017.
- [24] A.O. Ivanova. List 2-distance $(\Delta+1)$ -coloring of planar graphs with girth at least 7. *Journal of Applied and Industrial Mathematics*, 5(2):221–230, 2011.
- [25] S.-J. Kim, S.J. Lee, and W.-J. Park. Dynamic coloring and list dynamic coloring of planar graphs. *Discrete Applied Mathematics*, 161:2207–2212, 2013.
- [26] S.-J. Kim and B. Park. List 3-dynamic coloring of graphs with small maximum average degree. *Discrete Mathematics*, 341:1406–1418, 2018.
- [27] S.-J. Kim and W.-J. Park. List dynamic coloring of sparse graphs. *Combinatorial Optimization and Applications*, 6831:156–162, 2011.
- [28] F. Kramer and H. Kramer. Ein Färbungsproblem der Knotenpunkte eines Graphen bezüglich der Distanz p . *Revue Roumaine de Mathématiques Pures et Appliquées*, 14(2):1031–1038, 1969.
- [29] F. Kramer and H. Kramer. Un problème de coloration des sommets d’un graphe. *Comptes Rendus Mathématique Académie des Sciences, Paris.*, 268:46–48, 1969.
- [30] H.-J. Lai, H. Song, and J.-L. Wu. On r -hued coloring of planar graphs with girth at least 6. *Discrete Applied Mathematics*, 198:251–263, 2016.
- [31] K.-W. Lih, W.-F. Wang, and X. Zhu. Coloring the square of a K_4 -minor free graph. *Discrete Mathematics*, 269(1):303 – 309, 2003.
- [32] S. Loeb, T. Mahoney, B. Reiniger, and J. Wise. Dynamic coloring parameters for graphs with given genus. *Discrete Applied Mathematics*, 235:129–141, 2018.
- [33] B. Montgomery. Ph.d. dissertation. *West Virginia University*, 2001.
- [34] H. Song, S.-H. Fan, Y. Chen, L. Sun, and H.-J. Lai. On r -hued coloring of K_4 -minor free graphs. *Discrete Mathematics*, 315-316:47–52, 2014.
- [35] H. Song and H.-J. Lai. Upper bound of r -hued colorings of planar graphs. *Discrete Applied Mathematics*, 243:262–369, 2018.
- [36] H. Song, H.-J. Lai, and J. Wu. List r -hued chromatic number of graphs with bounded maximum average degrees. *Discrete Mathematics*, 341(5):1244–1252, 2018.
- [37] C. Thomassen. The square of a planar cubic graph is 7-colorable. *Journal of Combinatorial Theory, Series B*, 128:192–218, 2018.
- [38] G. Wegner. Graphs with given diameter and a coloring problem. *Technical report, University of Dortmund*, 1977.