



HAL
open science

Metrology of the hexapod positioning systems for ground system equipment: recent innovations, and state of the art of reachable performances

Pierre Noiré, Matthieu Cuq, Clément Robert, Thierry Roux, Sébastien Krut, Olivier Company, Alain Vissière

► To cite this version:

Pierre Noiré, Matthieu Cuq, Clément Robert, Thierry Roux, Sébastien Krut, et al.. Metrology of the hexapod positioning systems for ground system equipment: recent innovations, and state of the art of reachable performances. SPIE Astronomical Telescopes + Instrumentation Conference, SPIE, Jun 2024, Yokohama, Japan. 10.1117/12.3020420 . lirmm-04753894

HAL Id: lirmm-04753894

<https://hal-lirmm.ccsd.cnrs.fr/lirmm-04753894v1>

Submitted on 25 Oct 2024

HAL is a multi-disciplinary open access archive for the deposit and dissemination of scientific research documents, whether they are published or not. The documents may come from teaching and research institutions in France or abroad, or from public or private research centers.

L'archive ouverte pluridisciplinaire **HAL**, est destinée au dépôt et à la diffusion de documents scientifiques de niveau recherche, publiés ou non, émanant des établissements d'enseignement et de recherche français ou étrangers, des laboratoires publics ou privés.

Metrology of the hexapod positioning systems for ground system equipment's: recent innovations, and state of the art of reachable performances

Pierre Noiré^{*a}, Matthieu Cuq^a, Clément Robert^{ab}, Thierry Roux^a, Sébastien Krut^b, Olivier Company^b, Alain Vissière^c

^aSYMETRIE, 10 Allée Charles Babbage, 30000 Nîmes, France;

^bLaboratoire d'Informatique, de Robotique et de Microélectronique de Montpellier (LIRMM), UMR 5506 Montpellier Univ. and CNRS, Montpellier, France;

^cLaboratoire Commun de Métrologie (LCM), LNE/CNAM, Paris, France

ABSTRACT

This paper presents the performances of recent high-tech hexapod positioning systems. Those devices with six degrees of freedom, are commonly used in Ground System Equipment (GSE) design, to qualify and conduct, for example, optical performance test activities. They are frequently used in vacuum environments. This is the case for example for EUCLID, CHIME, PLATO missions. They are also commonly used on large scientific instruments like Telescope or synchrotrons.

The latest innovations in terms of the performances, measurement technology, stability and control of those positioners are presented. The know-how the manufacturer has mastered to mature this technology and push the boundaries is on display. The characterization of the performance in terms of resolution, repeatability, accuracy, cross-coupling, backlash, and stiffness is clarified. The methods and measurement instruments used to characterize each specification are explained. Then, the most advanced performances of different hexapod positioners are described in detail. The goal of this step is to provide the current state of the art of hexapod technology and describe the most advanced system. Ongoing innovations that could push the boundaries are also featured.

Finally, we present how engineers can specify their positioners to be integrated into the next generation of Ground Support Equipment (GSE). This analysis will include key parameters such as the stiffness, duty cycle, thermal management but also the control requirements.

Keywords: hexapod, resolution, repeatability, accuracy, cross-coupling, GSE, stiffness

INTRODUCTION

Hexapod robots or so-called Gough-Stewart platforms [1] are parallel robots with 6 degrees of freedom (DoFs). Positioning hexapods are increasingly being used for high accuracy 6-DOF positioning applications. These hexapods have migrated from research laboratories to industrial environments and are now used in many manufacturing facilities, particularly in the field of space industry or on large scientific equipment such as telescopes or synchrotrons.

ISO 230-2:2014 standard [2] specifies methods for testing and evaluating the positioning accuracy and repeatability of numerically controlled machine tool axes by direct measurement of individual axes on the machine. These methods apply equally to linear and rotary axes. This standard comes from the machine tool industry and is well suited to serial mechanisms. However, in the case of hexapods, when talking about repeatability, and especially, accuracy, the following questions need to be addressed:

- Is the accuracy unidirectional or bidirectional? Which parameter (A, E or M) should we consider?
- Is it single-axis accuracy, with all other axes in a central position? Or in an extreme work area position?
- Where is located the pivot point?

*pierre.noire@symetrie.fr; www.symetrie.fr

- Where is located the point of interest: i.e., the measurement point?
- What are the parasitic movements (cross-coupling) on the other axes?
- Is it a fixed value requirement or a value proportional to the covered stroke, with a minimum value?
- Under what environmental conditions should accuracy be guaranteed? Is the room temperature stable?
- It is necessary to ascertain whether the requirement is to be met with or without the payload mounted? For different loading cases?
- Is the qualification campaign relevant to the future use of the machine? The qualification cycle may warm up the machine and affect the accuracy result.
- How is the hexapod mounted: is it a horizontal or vertical orientation? Does the direction of gravity with respect to the machine change over time (example of telescope application)?
- Does the environment affect accuracy? Is the support frame stable enough, without vibrations?
- Is the relative accuracy (with respect to the moving frame, moving platform of the hexapod) or the absolute accuracy (with respect to the supporting frame, fixed platform of the hexapod) of interest?

All these questions should be answered prior to the specification of an accuracy requirement. Each project / need is different; however, it is crucial to clarify these points to avoid any potential misunderstandings.

This paper starts with some reminders of some useful definitions in the context of the precision concept. Then, the state of the art of common practices used to enhance and guarantee the accuracy / stability of positioning will be presented. Without fully answering all the previous questions, this paper presents some recent qualification campaigns performed on several positioning hexapods to demonstrate their high level of accuracy.

1. DEFINITIONS

Positioning system performance is often determined by the following terms: resolution, repeatability, accuracy, and stability. According to the International Vocabulary of Metrology (VIM) [3], resolution is defined as the "smallest change in a quantity being measured that causes a perceptible change in the corresponding indication". Based on this definition, a qualitative definition for positioning system resolution can be provided: Resolution – also called the minimum incremental motion (MIM) – is the smallest increment of motion that a robot can perform.

The definition of resolution and the method for its evaluation in the case of 6-degree-of-freedom precision positioning systems has been studied by A. Vissière [4]. The figure hereunder shows an example of small steps performed to demonstrate a resolution of $0.5 \mu\text{rad}$ (~ 0.1 arcsec). The measurements here were performed with a laser interferometer. It can be observed that the system exhibits good stability at each step. Furthermore, there is no relaxation behavior observed when the system reaches the commanded position.

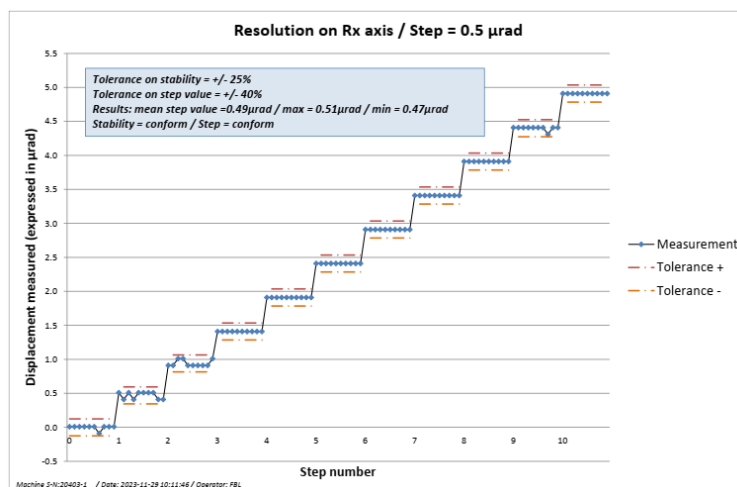

Figure 1. Example of resolution plot done to demonstrate the capabilities to command increment of $0.5 \mu\text{rad}$ around X axes.

A simple way to define repeatability and accuracy according to [5] is as follows:

- Repeatability is the ability to tell the same story over and over again.
- Accuracy is the ability to tell the truth. Mechanical accuracy is far more costly than repeatability!

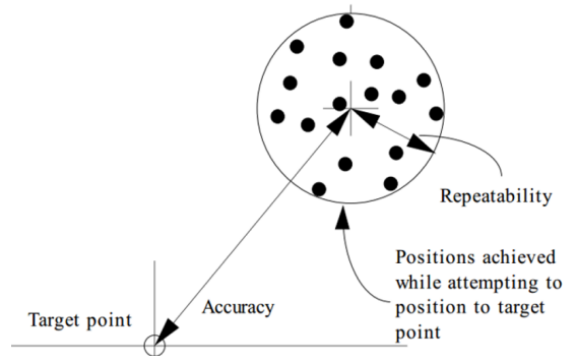

Figure 2. Illustration of the repeatability and accuracy of positioning,

Measurements were made according to the 'standard test cycle' which is described in the ISO 230-2 standard, and five bidirectional measurement runs were performed.

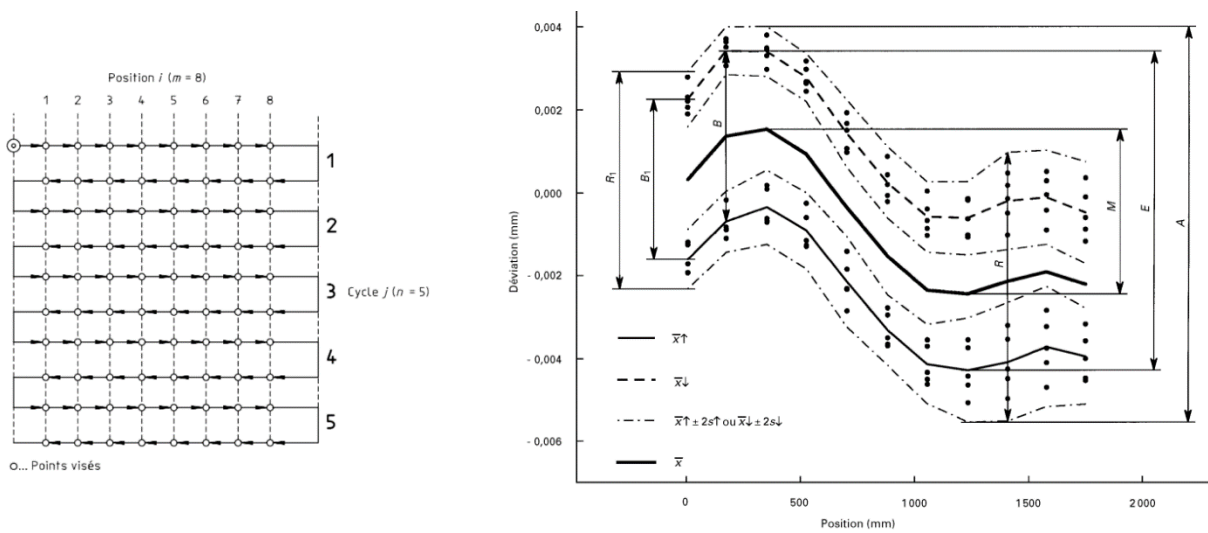

Figure 3. Standard cycle to evaluate the accuracy (on the left) and an example of error plot result (on the right)

This figure shows the different values that provide a basis for accuracy acceptance:

- A : Bidirectional accuracy,
- E : Bidirectional systematic deviation,
- M : Range of mean bidirectional positional deviation

In the same way, the unidirectional parameters can be introduced:

- Unidirectional accuracy, $A \uparrow$ (approach in the positive direction) and $A \downarrow$ (approach in the negative direction)
- Unidirectional systematic deviation, $E \uparrow$ (approach in the positive direction) and $E \downarrow$ (approach in the negative direction)

Mathematical equations to evaluate those parameters from a set of measurement are given in ISO 230-2:2014 standard document [2]. Different parameters (A , E or M) could be used to quantify the accuracy. It is important to elucidate which parameter should be taken in consideration when we are discussing the concept of accuracy.

2. METHODS TO IMPROVE THE ACCURACY

Positioning systems face several challenges, especially in meeting accuracy requirements:

- High accuracy of the hexapod actuators for large travel ranges,
- High stiffness of the actuators and platforms to avoid deformation when forces change due to motion, payload changes or when the machine is mounted on a moving structure (such as a gimbal or a telescope for example),
- Accurate identification of the hexapod kinematic model to reduce cross-coupling errors,
- Minimization of the components' heating (motors, encoders) to avoid thermal drift. Even more in a vacuum environment,
- Guarantee the thermal stability of the mechanism,

Mechanical design approach

The complete hexapod is composed of six identical legs. The precision actuators used on highly accurate hexapods are specifically designed by SYMETRIE. They integrate a motor with a zero-backlash reducer, a high-precision ball screw and an absolute linear encoder [6]. The linear encoder directly measures the length between the two joints. The actuator CAD model of a ZONDA hexapod [7] shown on the figure below, is compatible for operation under a vacuum.

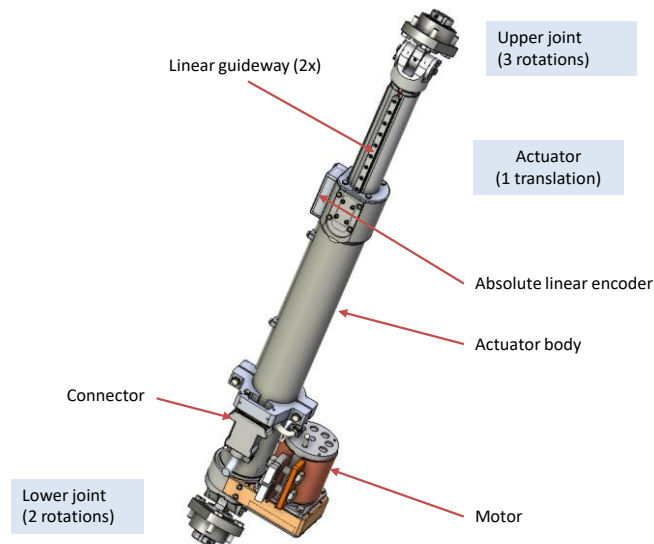

Figure 4: ZONDA actuator CAD model / principle.

This actuator presents the following characteristics:

- Resolution minimum incremental motion (MIM): $< 20\text{nm}$,
- Stroke: 275 mm ,
- Actuator driven force: 2000 N ,
- Accuracy on full stroke: better than $1\text{ }\mu\text{m}$,

SYMETRIE company has developed other precision actuators based on similar design, with larger load capacities (15kN for driven load) and larger stroke (~500 mm) for the JORAN hexapod [7] and other custom projects. Positioning performances in this case are similar. All moving components inside the actuator (bearings, ball screws, and mechanical parts) are adjusted and preloaded.

The mechanical design has been optimized to achieve the optimal stiffness and to increase the hexapod eigen frequency, considering the following constraints: mass, overall size, and cost. In our design, repeatability, stability, and accuracy are achieved through a dissociated metrological loop using INVAR material with low thermal expansion properties and an encoder scale tape (ZEROMET). For the effort chain, materials with high mechanical properties (such as steel, stainless steel, aluminum, etc.) are employed, as the accuracy and stability of the actuator are directly related to the metrological chain.

The effort chain and the metrological chain are kept as much as possible dissociated in the actuator design. The utilization of metrological chain enables the design of lightweight actuators for comparable accuracy performance. Despite this, heat generation is still an issue to reach high levels of performance accuracy, especially in a vacuum environment. It is challenging to rectify the errors related to the expansion of the components included in the metrological chain. To minimize their impact, we try to limit their expansion as much as possible. To improve the actuators stability, the different heat sources have been isolated to limit the thermal drift. The objective is to reduce the impact of convection and radiation. Here, we present the solutions recently used on a challenging project:

- Copper shells were added on the motors, as well as thermal braids connected to a cooling plate.
- The encoder read head was mounted on a copper part, which was connected to a copper braid to reach another copper part on the actuator body.
- The motors' temperature was maintained at a constant level through the use of heaters and temperature sensors.

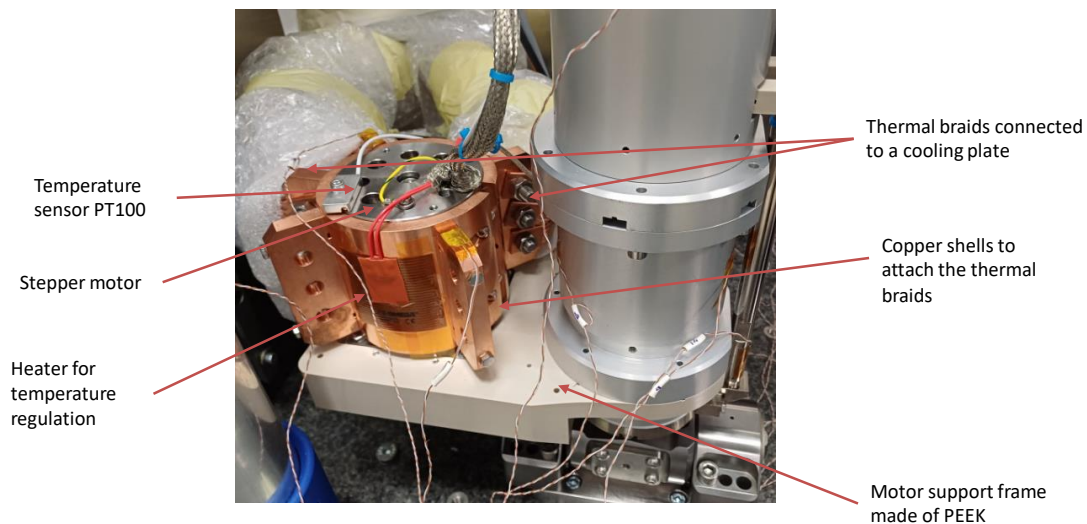

Figure 5: Customized actuator with thermal motor temperature regulation.

In order to guarantee the accuracy and stability of the actuator, a thermal study was conducted to ascertain the temperature evolution in the actuator due to the ambient temperature, and the heat dissipated by the motor, or the encoder read head of the actuators for a given use case. In practice, we have demonstrated a stability better than 50nm.

Calibration

Several types of calibrations (geometric, stiffness, etc.) are employed to achieve the highest possible accuracy in positioning capability. Depending on the final requirements of the project, some or all the solutions may be used to achieve the desired level of performance.

- Actuator calibration:

SYMETRIE company has developed a substantial expertise in the design of specific qualification test benches. The figure below shows a specific test bench developed to characterize and calibrate the actuators. This test bench is equipped with three linear laser interferometers and accepts some loading. Here is an illustration of this actuator control bench with a standard JORAN actuator mounted on it. This test bench is compatible with various actuator sizes.

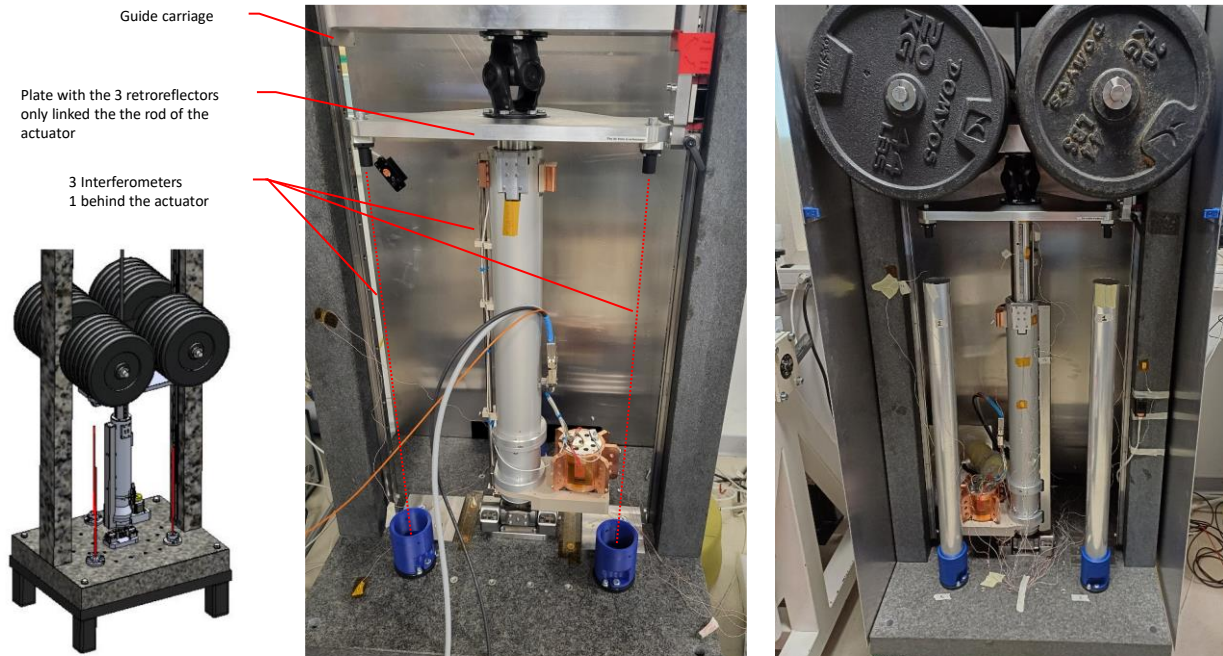

Figure 6: Test bench used to characterize and calibrate the actuator.

This test bench can also be instrumented with temperature sensors to verify its stability performance. In this instance, aluminum tubes are mounted around the laser beam to restrict variations in air temperature variations and the complete test bench is fully enclosed.

The following plots illustrate an example of an accuracy error that was reached prior to and subsequent to a calibration on a prototype actuator. In the absence of compensation, a periodic error cycle may be observed on the plot. The period is due to the ball screw pitch. This error is attributed to the ball screw accuracy. In addition, the linear encoder is not mounted along the actuator axis. So, Abbé principle [8] is not respected here due to mechanical design constraints. A compensation table is set in the controller to take the measurement into account. A calibration at the actuator level can enhance the accuracy and cross-coupling of the hexapod by a factor of 5.

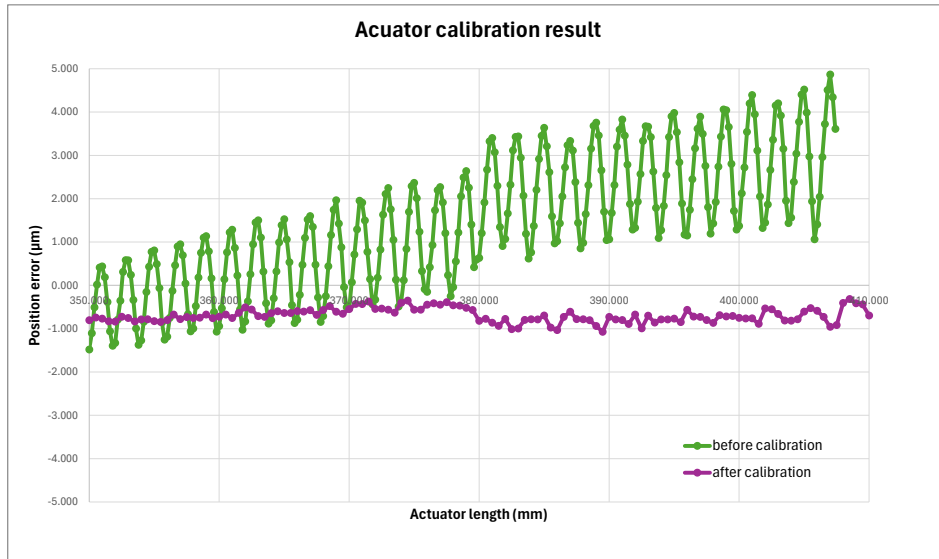

Figure 7: Example of actuator accuracy results reach on a prototype actuator before and after calibration.

- Kinematic model calibration:

The hexapod's kinematic model can be determined using external 3D measurement device. In our case, the kinematic model is identified once the machine is fully assembled. By measuring different poses (3 coordinates: X, Y and Z) with an external measurement device, it is possible to determine the optimal kinematic parameters that minimize the accuracy error on each pose.

Depending on the machine size and the accuracy needed, a coordinate measuring machine or a laser tracker can be used. The measurement process can be fully automated as it consists of measuring the different poses (6DoF) with the external device and repeating the measurement cycle several times to minimize the error.

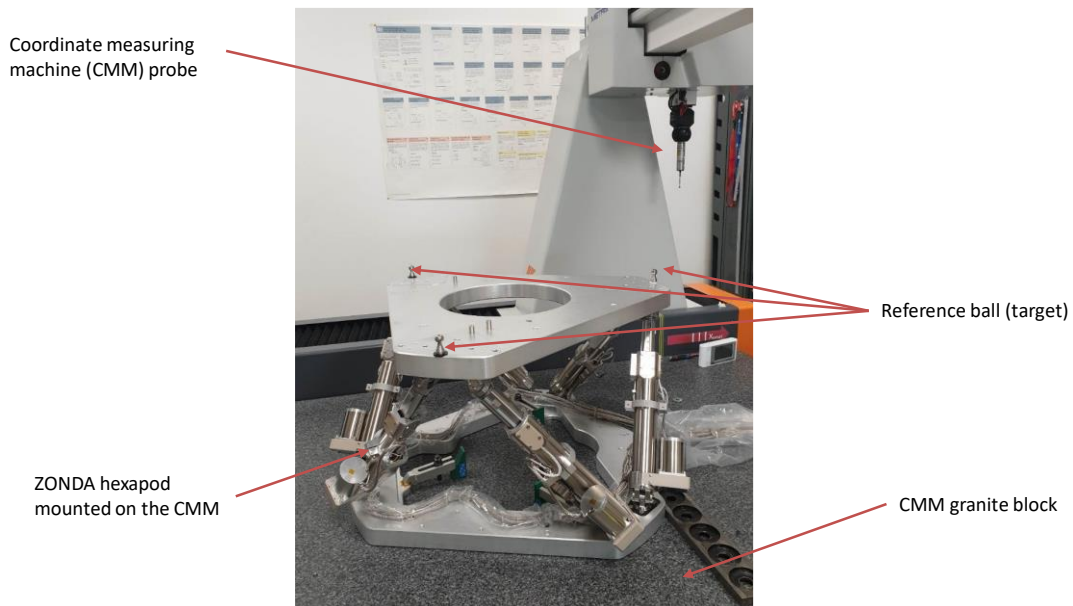

Figure 8: Setup of kinematic model calibration using a coordinate measuring machine (CMM)

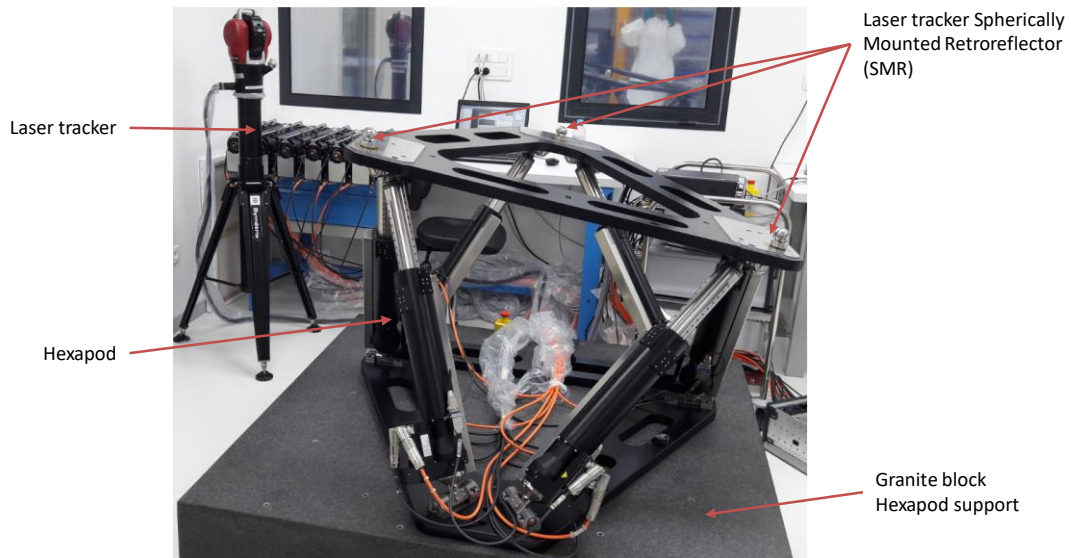

Figure 9: Setup of a kinematic model calibration using a laser tracker. The hexapod here as part of the OGSE is used for the characterization and calibration of the Sentinel 5 UVNS instrument (Copernicus mission).

To enhance the precision of the measurement, this process can be carried out with the hexapod mounted according to its final installation specifications and with the load installed on the mobile platform.



Figure 10: Setup of kinematic model calibration using a coordinate measuring machine (CMM). Here the hexapod is mounted in horizontal configuration and with a dummy load mounted on the mobile platform to be equivalent to the end application. ZONDA hexapod calibrated here is part of the SPECSID OGSE in the frame of the CHIME instrument.

Hexapod poses should be selected to cover the greatest possible part of the workspace, with the objective of identifying the relevant parameters. The number of poses can be increased to minimize the uncertainty of the calibration. Similarly, the number of targets to be measured on the mobile platform can be increased to minimize the uncertainty of the 3D external measurement device. Also, a strategy can be used to eliminate the impact of thermal deflection of hexapods on the pose measurement, thereby enhancing the accuracy of the calibration [9].

- Look up table to compensate accuracy error in the workspace:

If the previous methods are not sufficient, it is possible to incorporate a calibration function within the controller. The proposed calibration methodology involves the application of external measurements and the interpolation of data between the points of a look-up table. The proposed strategy can be summarized by the following figure. In consideration of the measurement time and the embedded controller's storage size limitation, it is necessary to limit the number of reference points in the look-up table.

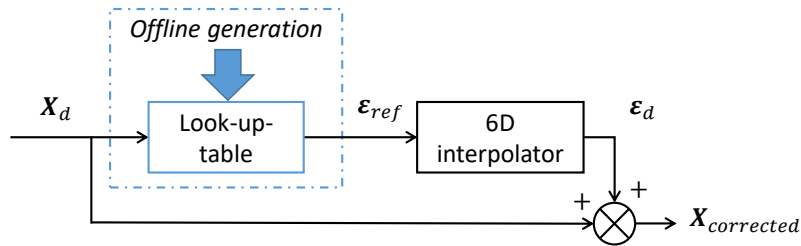

Figure 11: Look-up table strategy for calibrating the hexapod position in the workspace.

This method can be employed to improve the accuracy and the cross-coupling performance. The principle is to define a set of n reference points within the hexapod workspace. The hexapod is commanded to this set of reference points and the associated positioning errors are subsequently measured with an external measuring device. The dimension of the positioning errors is equal to six, which is the hexapod number of DoF.

To counterbalance the positioning errors online, a 6-dimensional interpolation algorithm must be executed. First, for a desired point to be included in the hexapod workspace, the 6-dimensional interpolator must identify the $2^6=64$ reference points that surround it. Given that the problem is defined in six dimensions, these reference points are the vertices of a 6-polytope. The final step is to calculate the operational error, to be compensated at point using a barycenter method applied to the known 64 nearest references.

SYMETRIE has successfully used this method on a large hexapod with a pivot point far away from the mobile platform. A CMM was used for external measurement. This positioning hexapod was developed for the qualification of SSDA instrument for MTG (Meteosat Third Generation) satellites. Project key features: payload: 500 kg, accuracy: 5 μm over 150 mm at the pivot point (500 mm in front of the pupil exit), large rotation amplitude Rx, Ry $\sim\pm 5$ deg at pivot point, mobile platform constitutes an integral component of the instrument and a high stability as a result of the utilization of Invar material and dissociated metrological frame.

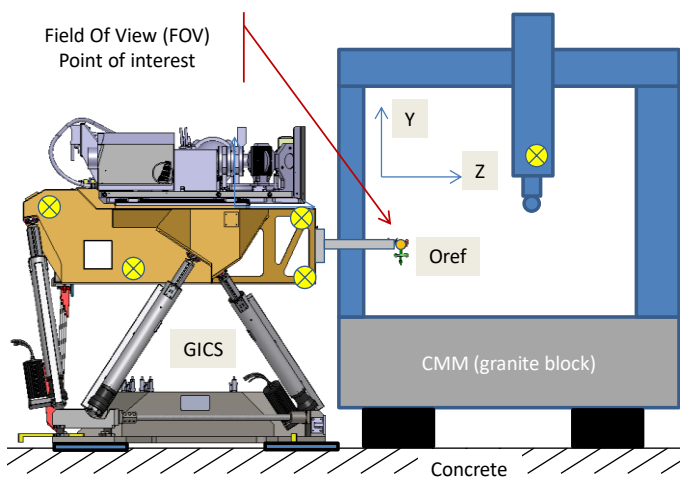

Figure 12: Setup with CMM used to determine the look-up table (on the left) / Photo of the hexapod on customer site with instrument mounted on it. Photo on the right copyright Bertin Technologies.

- Stiffness modelling and compensation:

The forces exerted by the actuators are subject to change due to movement executed, the payload in question or, when the machine is mounted on a moving mechanism, such as a gimbal or telescope. Consequently, the accuracy of the measurement is reduced due to the stiffness of the mechanism. The utilization of a metrological chain enables to mitigate this impact, as the degree of deformation is partially measured. Nevertheless, a model can be implemented to compensate for the kinematic model change due to the stiffness of all other components.

We have successfully implemented a stiffness compensation model on a ZONDA hexapod, which has been used with different loading cases. This model accounts for the first-order stiffness of the actuator and joint. To ensure accuracy, it is of paramount importance to configure the payload characteristics mounted on the machine (mass and center of gravity) in the software. This topic has been studied in the past by V. J. Kalas [10], on a shared research project.

This solution was conducted on a customized ZONDA hexapod. The hexapod is mounted on top of a rotation stage and installed in a large thermal vacuum chamber. This hexapod is capable of carrying different instruments with various mass up to 300kg. The instrument is illuminated with variety of angles, with a maximum tilt of 15 degrees, relative to an optical stimulus. The hexapod should guarantee an accuracy of 0.001 degrees over a wide temperature range.

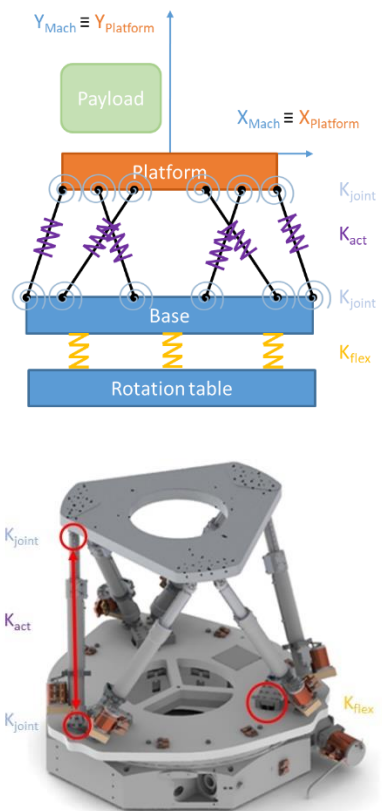

Figure 13: On the left photo of customized Zonda hexapod during installation in the thermal vacuum chamber / Copyright TNO. Stiffness compensation model principle on the right.

- Thermal modelling and compensation

Each time the hexapod is moved, the motors in each actuator generate heat. This heat causes the leg to expand. To ensure that the expansion does not affect the performance of the hexapod, it is necessary to construct a model that can compensate for it in real time. The testbed depicted in the figure below was therefore constructed to jointly measuring the temperature profile and thermal expansion of a leg during a series of heating and cooling operations. This testbed was designed so that the hexapod leg would be as close as possible to the real operating conditions.

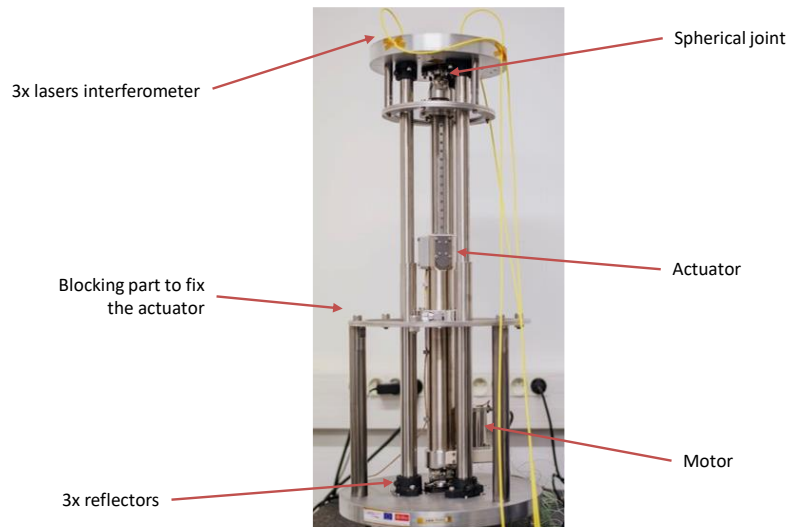

Figure 14: Test bench used to verify the actuator heating modelling.

The length of dilatation was quantified using three interferometers with beams aligned parallel to the actuator axis. The temperature profile along the actuator was quantified by means of multiple thermocouples. A thermal compensation model was developed and then cross-validated on a new set of measurements. The maximum thermal drift observed during the cross-validation measurement was $7.81 \mu\text{m}$. This maximum drift was observed during a test in which the leg position setpoint changed almost continuously. The residual error, i.e., the difference between the actual expansion and the predicted expansion, only reached a maximum of $1.28 \mu\text{m}$, i.e., $> 80\%$ reduction. This reduction was also verifiable on other metrics. For instance, the average absolute value of the actual thermal expansion was $2.50 \mu\text{m}$. The average absolute residual error value was only $0.28 \mu\text{m}$, corresponding to a $> 85\%$ reduction. This approach yielded satisfactory results. A further implementation on a complete hexapod remains to be carried out.

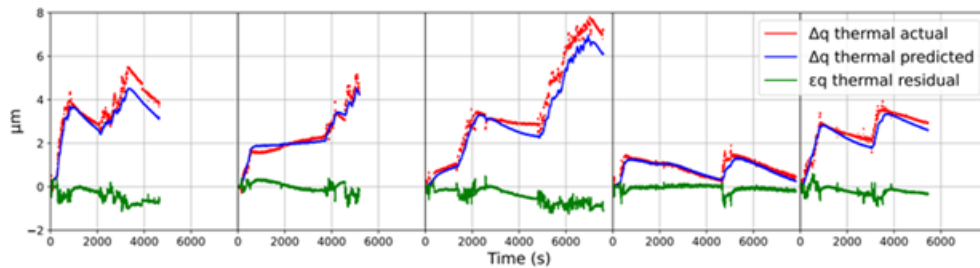

Figure 12: The red dots show the interferometric measurement value of the thermal drift over time, the blue line shows the predicted thermal drift value. The green curve represents the measured deviation over time between the interferometric measurement curve and the predicted curve.

3. MEASUREMENT SETUP & RESULTS

This paragraph presents the test setups employed to demonstrate the performance of recent high-tech hexapod positioning systems.

COTS measurement equipment's

To verify the resolution, repeatability, and accuracy, a laser interferometer with linear or angular optics is commonly employed. This equipment permits to measure the displacement only on a single axis at a time. The device is accompanied by a dedicated software that enables the user to obtain the results in accordance with the ISO 230-2 standard, or indeed other standards. The figure below illustrates an example of setup used to assess the resolution, repeatability, and accuracy performances of linear or angular axes.

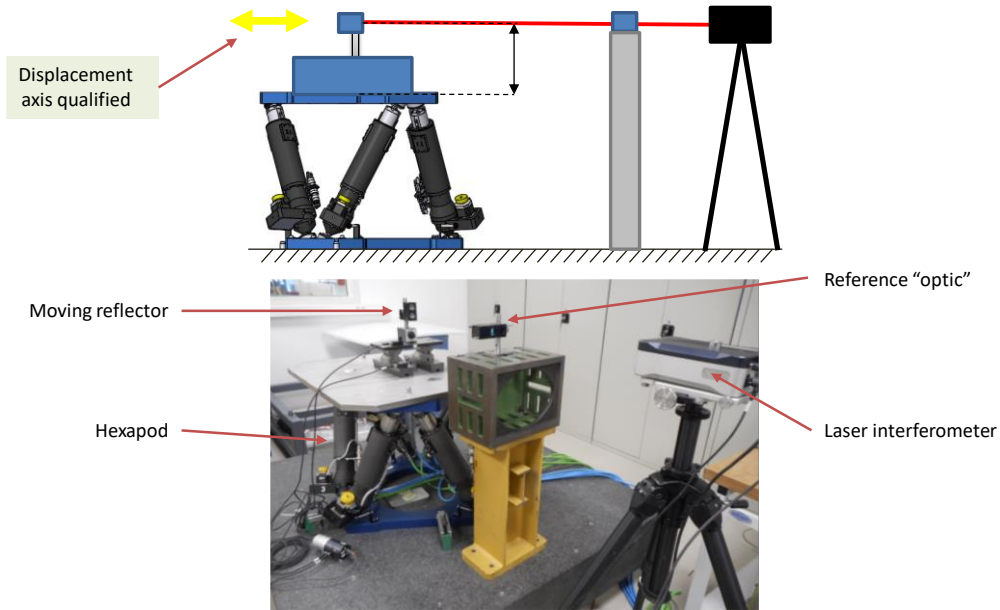

Figure 15: Example of setup with a laser interferometer used to demonstrate the linear positioning performances.

The figure below gives an example of accuracy plot in which all parameters have been calculated:

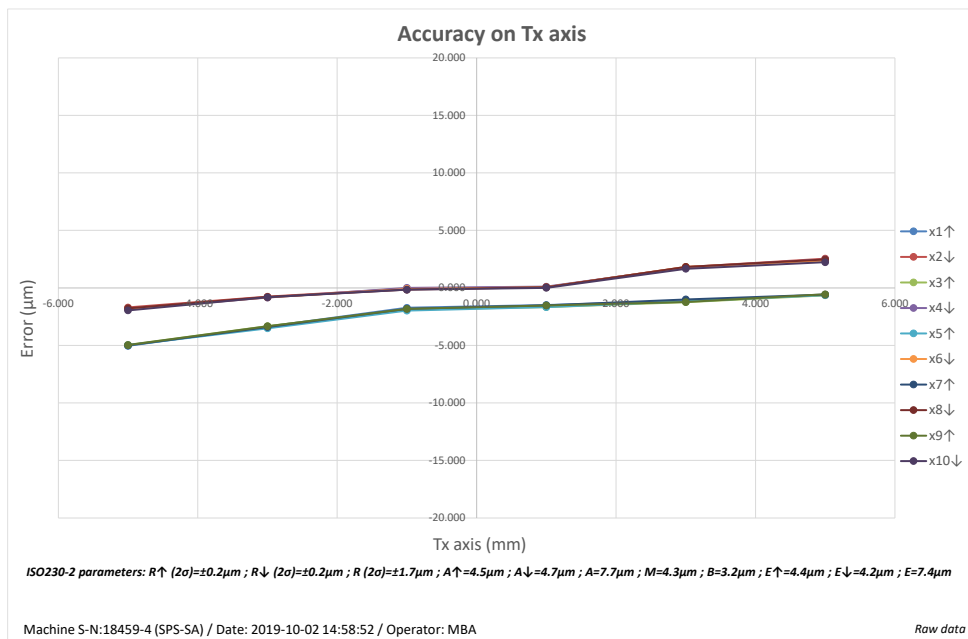

Figure 16: Example of accuracy plot in which all ISO230-2 parameters have been calculated.

To permit the measurement of the 6 degrees of freedom simultaneously from a single setup, SYMETRIE is also equipped with a multi-axis calibrator, the Renishaw XM-60 [12]. This instrument enables the characterization of the displacement of a linear axis and the simultaneous measurement of the parasitic motions on the 5 other axes. The figure below illustrates an example of an accuracy plot measured on a linear axis with a stroke of +/-100mm. The cross-coupling (crosstalk) on the other axes is also measured simultaneously.

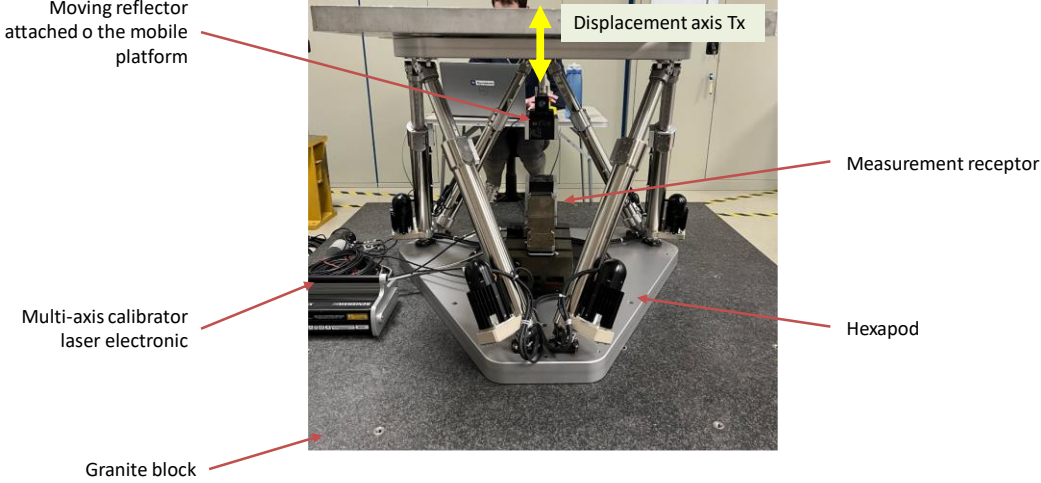

Figure 17: Example of measurement setup with a multi-axis calibrator used to demonstrate the linear accuracy on X axis and cross-coupling (crosstalk).

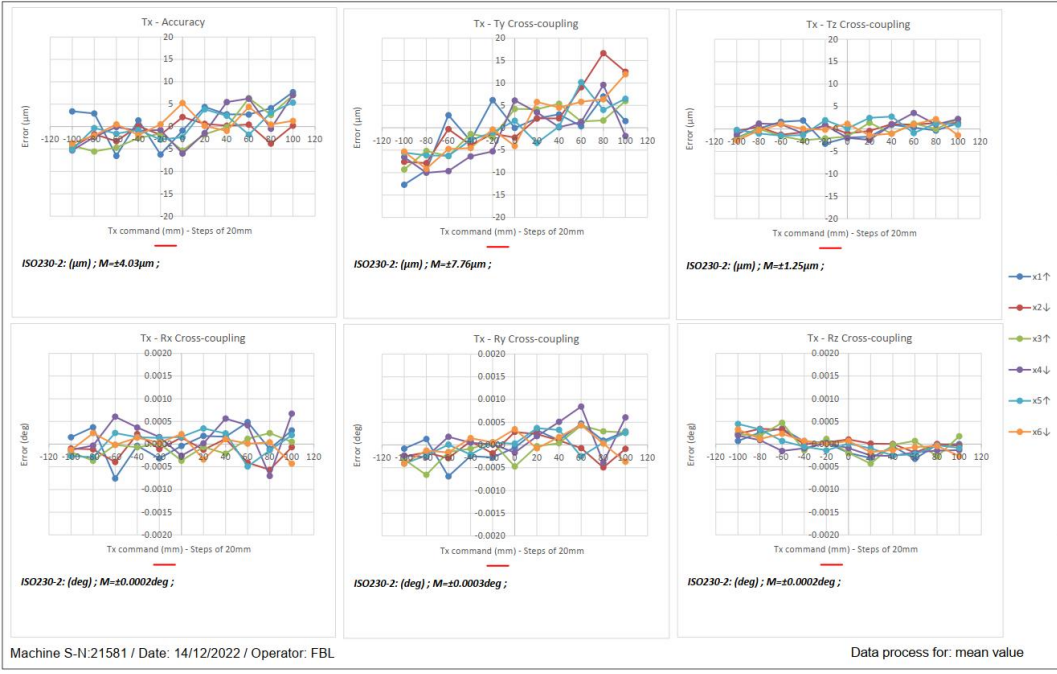
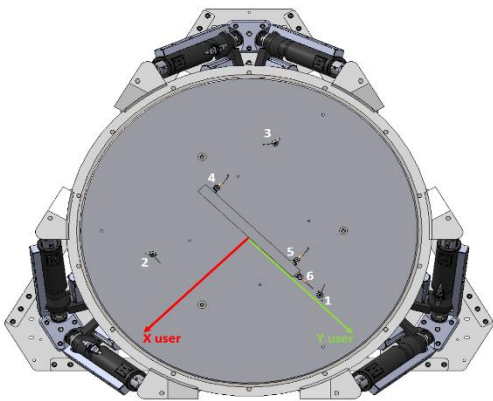

Figure 18: Example of measurement results get with a multi-axis calibrator used to demonstrate the linear accuracy on X axis and cross-coupling (crosstalk).

Custom made qualification 6dof measurement device

In instances where a single setup is required for the performance of 6DoF measurements, SYMETRIE is also capable of developing dedicated tests setup equipped with several sensors. The choice of measurement sensor depends on the stroke required and the desired level of accuracy. Possible options include capacitive sensors, digital gauges or fiber laser interferometers for example.

The following section presents the setup developed to qualify the high precision hexapods used to calibrate the 931 mirror segments of the primary mirror (M1) of the European Extremely Large Telescope, E-ELT. The setup is composed with 6 capacitive sensors. Each sensor has a relatively narrow measurement range of about 300 μm (with a full range of 500 μm). Each sensor is fixed to the reference support via a magnetic base. The capacitive sensors setup is employed to evaluate the resolution, accuracy/cross-coupling and stability.



Project highlights:

Payload mass: 2 tons / width of mirror segment is ~ 1.40 m.

Hexapod size: height 545mm in middle position,

Overall diameter :2000 mm,

Incorporate a 360 ° turntable integrated in the mobile platform,

Resolution of 0.1 μrad

Excellent stability of 0.1 μrad over 1 hour.

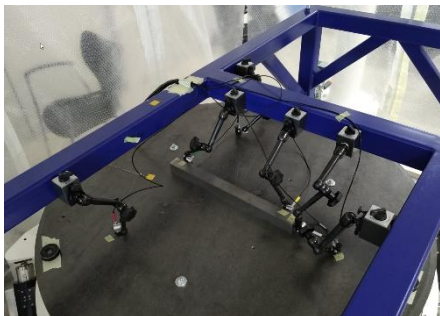
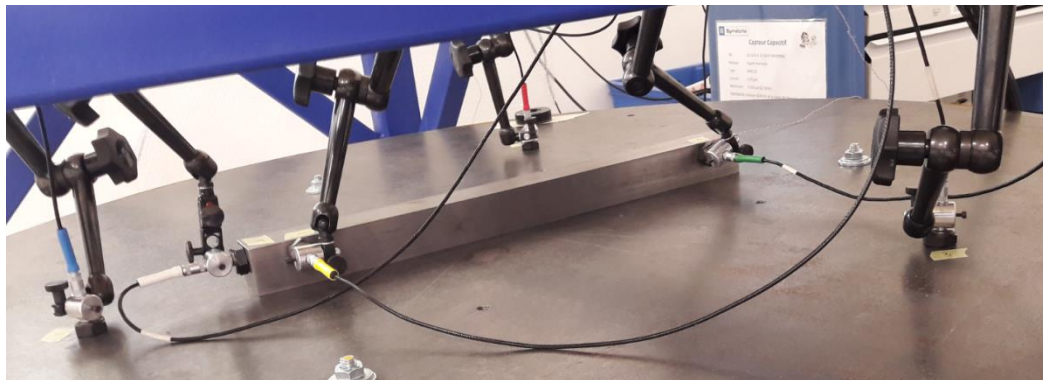

Figure 19: Setup with 6 capacitive sensors to measure positioning performances on the 6 degrees of freedom at the same time.

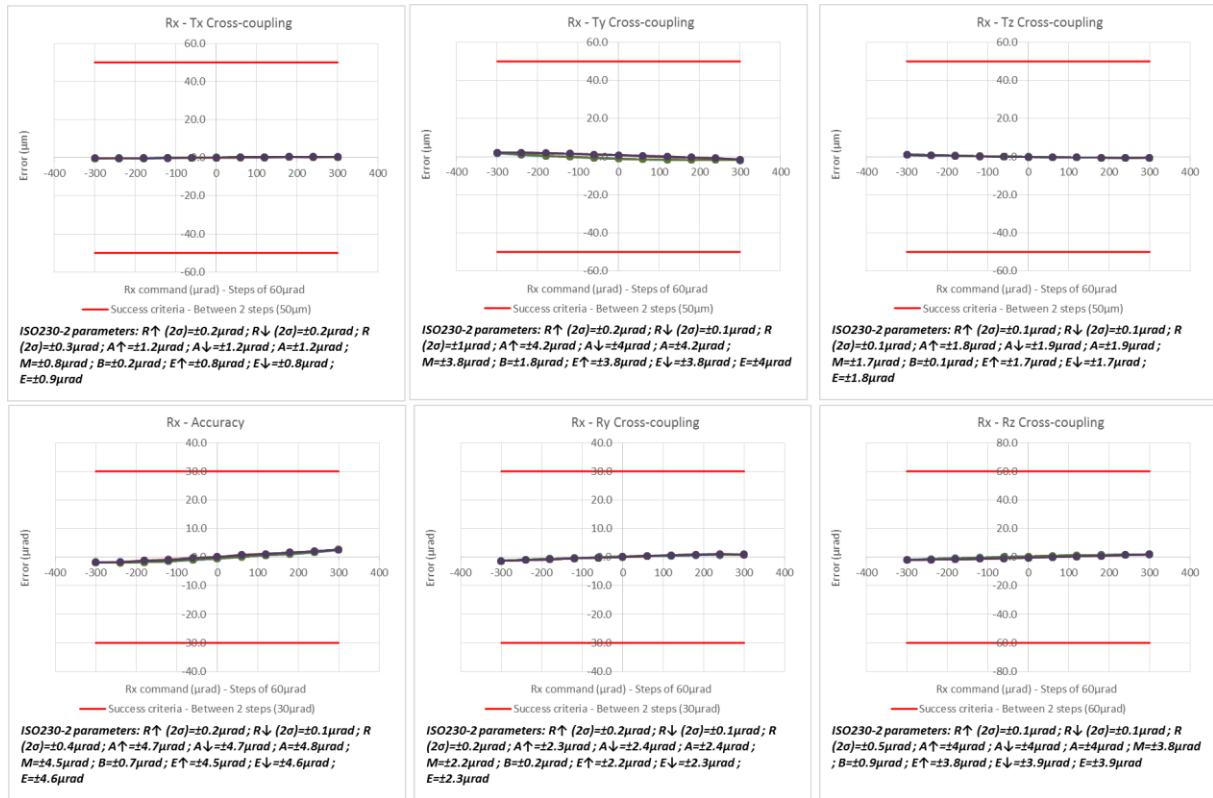

Figure 20: Example of angular accuracy (Rx) and cross-coupling results on the other axis, using this 6-dof measure setup.

A similar measurement device has been employed to qualify hexapods developed to support a M2 mirror on optical telescopes. A configuration composed of six capacitive sensors is employed, enabling simultaneous measurement of 6 DoF within a limited range of motion. This approach facilitates the assessment of resolution, repeatability, accuracy/cross-coupling and stability. The instrumentation is localized between the two platforms. The fixed component is connected to the hexapod support frame while the mobile part is bounded to the M2 dummy. Measurements are conducted as closely as possible from M2 vertex. Given the geometry of the dummy, it is not possible to perform a measurement at the vertex point. Due to the 6 DoF measurements, the results are expressed at the M2 vertex, which is equivalent to the pivot point, after post-processing.

Setup with a pivot point located far away

Hexapod positioning systems are capable of 6 degrees of freedom. Consequently, the pivot may be configured at any point in space within the control software. In certain applications, the pivot point (rotation center) may be situated at a considerable distance from the hexapod mobile platform. This is exemplified by the FRF JORAN hexapods employed for the characterization and calibration of the Sentinel 5 UVNS instrument. In this instance, the pivot point is situated at a distance of 4m from the center of the mobile platform.

Project highlights:

- Payload mass: 400kg with a center of gravity off centered of $\{T_x = \pm 150 \text{ mm}, T_y = 500 \text{ mm}, T_z = 0 \text{ mm}\}$ in Machine coordinates system,
- Hexapod size: height 700mm in middle position,
- Overall diameter :1510 mm,

- Movement required regarding the pivot point situated at 4m from payload (mobile platform),
- The requirement on the project was: accuracy (E) should not exceed $14.5 \mu\text{rad}$ for R_y rotations.

Telescope measurement with R_y scan

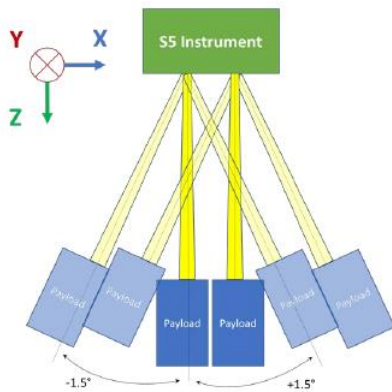

Telescope measurement with R_x scan

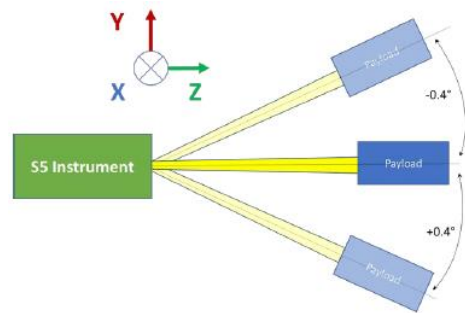
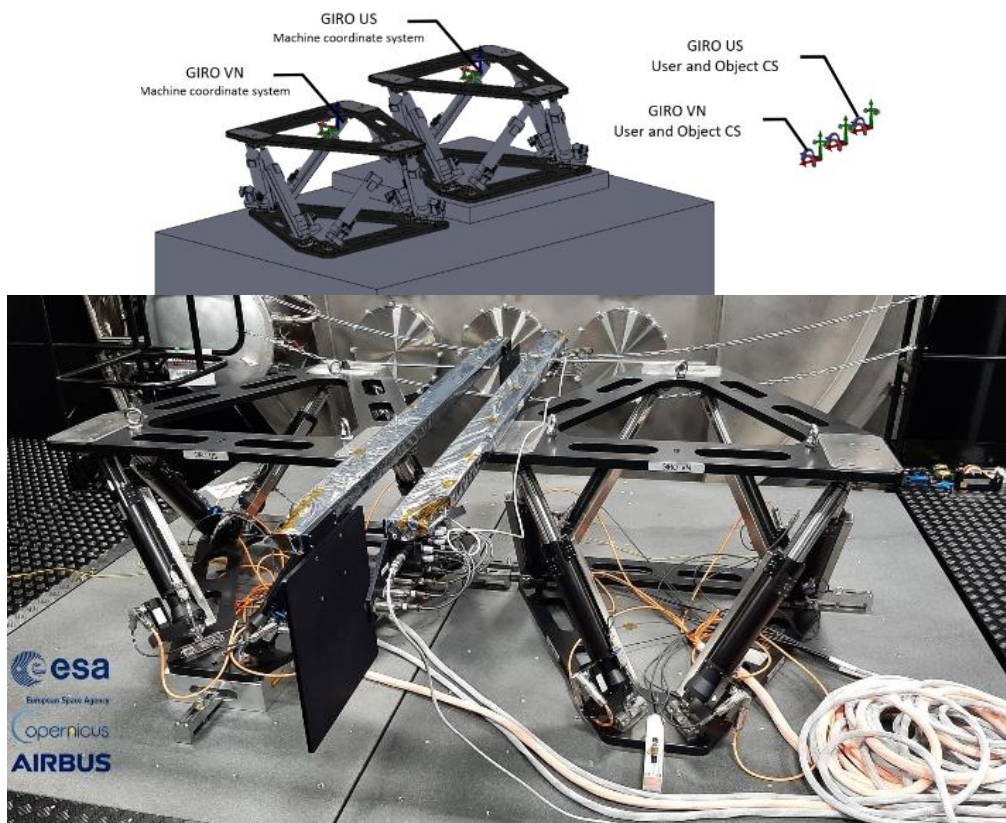

Figure 21: Required movement on the project.

It is of paramount importance to ascertain the positioning error at the point of interest. In this instance, a laser tracker is employed to make measurements, for different hexapod poses. The installation of multiple measuring targets on the mobile platform, enables the reconstruction of the mobile platform's position (6 DoF). Thus, allowing to calculate movements performed at the pivot point. During the tests conducted in the metrology laboratory, the hexapod is loaded with a dummy load that is representative of the end-user application. The measurement process is fully automated.



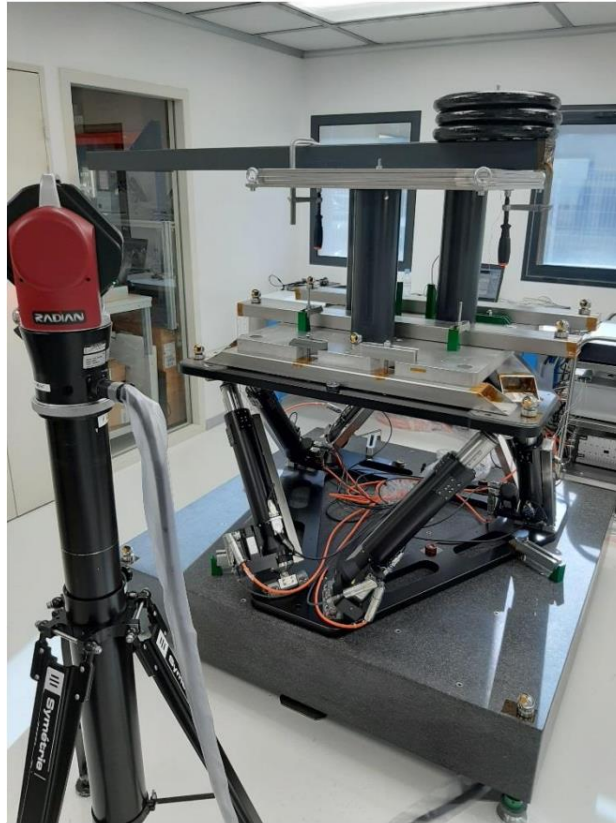

Figure 22: FRF JORAN hexapod systems installed on customer site (top). Qualification setup done to demonstrate the angular accuracy during FAT tests (bottom) Those hexapods as part of the OGSE were used for the characterization and calibration of the Sentinel 5 UVNS instrument (Copernicus mission).

Table below show synthesis the accuracy / cross-coupling when rotating around Y axis. Plots are also provided.

Axis		Tx	Ty	Tz	Rx	Ry	Rz
		Cross-coupling	Cross-coupling	Cross-coupling	Cross-coupling	Accuracy	Cross-coupling
Units		(μm)	(μm)	(μm)	(μrad)	(μrad)	(μrad)
E \uparrow	\pm	11.5	25.2	5.5	7.0	3.0	6.2
E \downarrow	\pm	8.4	16.6	8.1	8.2	1.9	7.0
E	\pm	11.5	26.1	8.1	8.2	3.0	7.0
E Success criteria	\pm	100.0	100.0	100.0	14.5	14.5	14.5
Conform?		Conform	Conform	Conform	Conform	Conform	For information

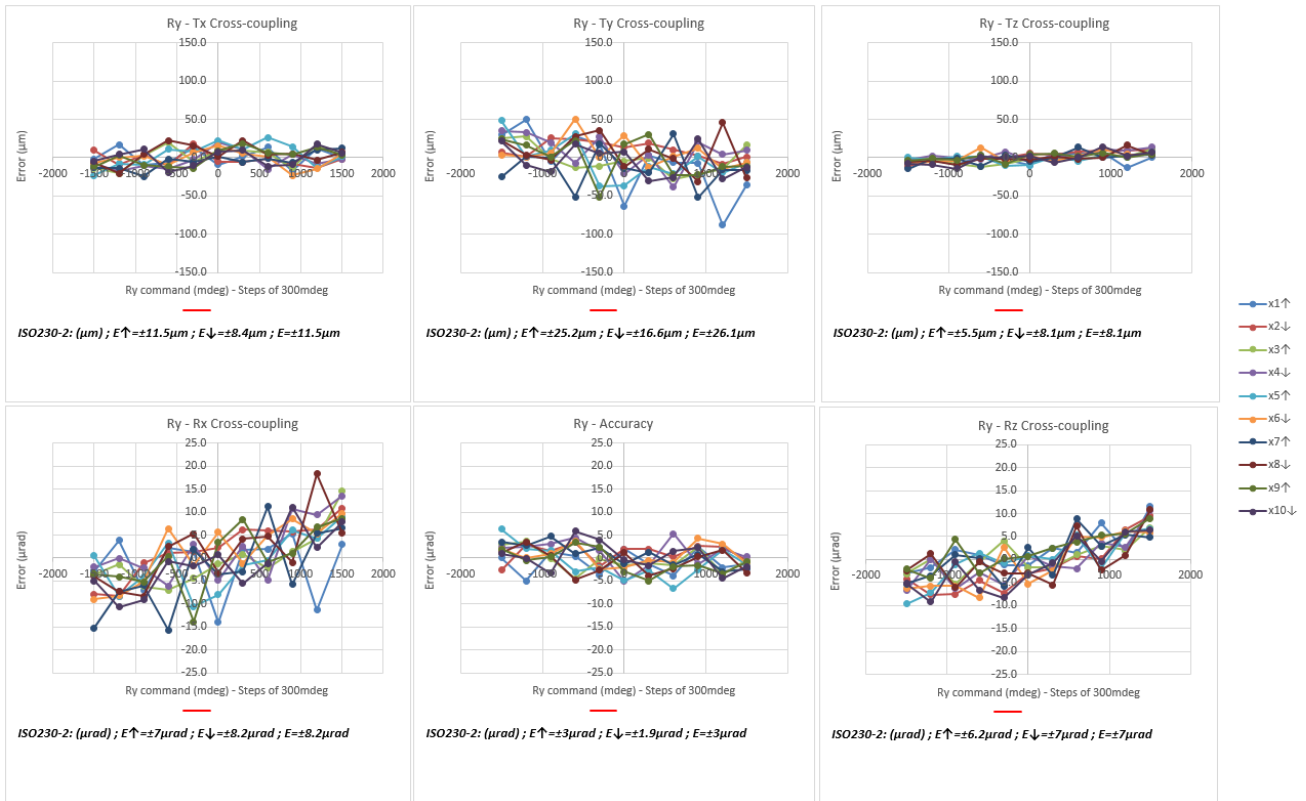

Figure 13: Example of angular accuracy (Ry) and cross-coupling results on the other axis, using the laser setup.

CONCLUSIONS

The criteria of accuracy and stability are becoming increasingly important in the field of hexapod positioning systems. The requisite performance levels are closely aligned with the precision of the most advanced measurement instruments precision (CMM, laser, etc.). The accuracy of a hexapod is constrained by the following contributors: geometric errors in all components, kinematic errors, calibration errors, load induced errors, thermal errors, dynamic errors, and eventually computational errors.

The achievement of accuracy can be facilitated through several techniques: including design, modelling, and calibration. Over the years, we have implemented significant improvements to the mechanical design of our actuators and calibration solution, thereby achieving high levels of accuracy and precision. Furthermore, we have developed a substantial body of experience in the design of qualification setups, which are used to demonstrate the real-world performance of positioning hexapod systems.

The extent of the work required can vary considerably, depending on the level of performance that is required. The technical solution selected, along with the associated development and qualification phases, has a significant impact on the overall cost of the system. It is of the utmost importance to correctly specify the requirement and the manner in which it will be demonstrated.

REFERENCES

- [1] D. Stewart, "A Platform with Six Degrees of Freedom", Volume 180 Issue 1, June 1965
https://doi.org/10.1243/PIME_PROC_1965_180_029_02
- [2] "ISO 230-2:2014, Test code for machine tools, Part 2: Determination of accuracy and repeatability of positioning of numerically controlled axes," 2014.
- [3] BIPM, International vocabulary of metrology – Basic and general concepts and associated terms (VIM), (2012)
- [4] A. Vissiere, S. Krut, T. Roux, P. Noiré and F. Pierrot, "Resolution evaluation of 6-degree-of-freedom precision positioning systems: Definitions and apparatus" Measurement, 2020
<https://doi.org/10.1016/j.measurement.2019.107375>
- [5] A. H. Slocum, "Precision Machine Design", 1992.
- [6] Renishaw's RESOLUTE encoder system
<https://www.renishaw.com/en/symetrie-hexapods-choose-renishaws-advanced-resolute-absolute-encoders--38342>
- [7] SYMETRIE Positioning hexapods
Available at: <https://www.symetrie.fr/en/products/positioning-hexapods>
- [8] J. B. Bryan, "The Abbé Principle Revisited: An Updated Interpretation," Precision Engineering, 1979.
- [9] V. J. Kalas, A. Vissière, S. Krut, P. Noiré, T. Roux and F. Pierrot "Thermal deflection decoupled 6-DOF pose measurement of hexapods", EUPSEN, Geneva, 2020
<https://doi.org/10.48550/arXiv.2006.04448>
- [10] V. J. Kalas, A. Vissière, S. Krut, P. Noiré, T. Roux and F. Pierrot "Application-oriented selection of poses and forces for robot elastostatic calibration", Mechanism and Machine Theory, Volume 159, May 202
<https://doi.org/10.1016/j.mechmachtheory.2020.104176>
- [11] Renishaw XL-80 laser interferometer, <https://www.renishaw.com/en/xl-80-laser-system--8268>
- [12] Renishaw XM-60 multi-axis calibrator, <https://www.renishaw.com/en/xm-60-and-xm-600-multi-axis-calibrator--39258>