



HAL
open science

Data Access over Large Semi-Structured Databases A Generic Approach Towards Rule-Based Systems

Bruno Paiva Lima da Silva

► **To cite this version:**

Bruno Paiva Lima da Silva. Data Access over Large Semi-Structured Databases A Generic Approach Towards Rule-Based Systems. Artificial Intelligence [cs.AI]. Université Montpellier 2, 2014. English. NNT: . tel-01088101

HAL Id: tel-01088101

<https://hal-lirmm.ccsd.cnrs.fr/tel-01088101>

Submitted on 27 Nov 2014

HAL is a multi-disciplinary open access archive for the deposit and dissemination of scientific research documents, whether they are published or not. The documents may come from teaching and research institutions in France or abroad, or from public or private research centers.

L'archive ouverte pluridisciplinaire **HAL**, est destinée au dépôt et à la diffusion de documents scientifiques de niveau recherche, publiés ou non, émanant des établissements d'enseignement et de recherche français ou étrangers, des laboratoires publics ou privés.

ACADÉMIE DE MONTPELLIER

UNIVERSITÉ MONTPELLIER II

Sciences et Techniques du Languedoc

PH.D THESIS

présentée au Laboratoire d'Informatique de Robotique
et de Microélectronique de Montpellier pour
obtenir le diplôme de doctorat

Spécialité : **Informatique**

Formation Doctorale : **Informatique**

École Doctorale : **Information, Structures, Systèmes**

Data Access over Large Semi-Structured Databases

A Generic Approach Towards Rule-Based Systems

par

Bruno PAIVA LIMA DA SILVA

Soutenance prévue pour le 13 Janvier 2014, devant le jury composé de :

Supervisor

Marie-Laure MUGNIER, Professeur LIRMM, Université Montpellier II

Joint supervisor

Jean-François BAGET, Chargé de Recherche INRIA, LIRMM, Montpellier

Madalina CROITORU, Maître de Conférences LIRMM, Université Montpellier II

Reviewers

Olivier HAEMMERLÉ, Professeur IRIT, Université Toulouse III

Fabien GANDON, Dr. & HDR INRIA, Sophia-Antipolis

[To be determined]



Contents

Contents	iii
1 Introduction	1
1.1 Introduction and motivation	1
1.2 Research Problem	3
1.3 Thesis structure	4
1.4 Evaluation	5
2 Rule-Based Data Access (RBDA)	7
2.1 Chapter Overview	7
2.2 Foreword	8
2.2.1 Problem presentation	8
2.2.2 Example	9
2.3 Facts	11
2.3.1 Syntax	11
2.3.2 Semantics	12
2.3.3 Computing	13
2.3.4 Complexity	13

2.4	Rules	14
2.4.1	Syntax	14
2.4.2	Semantics	14
2.4.3	Algorithms	15
2.4.4	Complexity and decidability	17
2.5	Other languages	19
2.5.1	RDF	19
2.5.2	Description Logics	21
2.6	Conclusion	22
3	Tools for RBDA	25
3.1	Chapter Overview	25
3.2	Problem Evolution	26
3.2.1	Large KBs	26
3.2.2	Semi-structured	27
3.2.3	NoSQL	27
3.3	Novelty and motivation	28
3.4	Prolog	30
3.4.1	Loading a knowledge base	30
3.4.2	$F \models Q$ and $F, \mathcal{R} \models Q$	31
3.5	Relational databases	32
3.5.1	Loading a knowledge base	33
3.5.2	$F \models Q$	33
3.5.3	$F, \mathcal{R} \models Q$	34
3.6	CoGITaNT	35
3.6.1	Loading a knowledge base	36
3.6.2	$F \models Q$ and $F, \mathcal{R} \models Q$	37
3.7	Graph databases	38
3.7.1	Loading a knowledge base	39

3.7.2	$F \models Q$ and $F, \mathcal{R} \models Q$	41
3.8	Discussion	42
4	ALASKA	45
4.1	Chapter Overview	45
4.2	Introduction to ALASKA	46
4.3	Foundations of ALASKA	48
4.4	Querying Algorithms	50
4.4.1	Backtracking algorithm	50
4.4.2	Abstract Procedures	52
4.5	Storage systems	54
4.5.1	Relational databases	56
4.5.2	Graph databases	57
4.5.3	Triples stores	58
4.6	Example	59
4.7	ALASKA for RBDA	64
4.8	Use cases for ALASKA	65
5	Experimental Work	69
5.1	Chapter Overview	69
5.2	Knowledge base storage	70
5.2.1	Relational databases	70
5.2.2	Graph databases	73
5.2.3	Triples Stores	76
5.3	ALASKA operations	78
5.3.1	Retrieving all the atoms with a given predicate	78
5.3.2	Listing the terms connected to a given term with a given predicate	79
5.3.3	Verifying the existence of a given atom	81
5.4	Input Data	82
5.5	Storage	83

5.5.1	Workflow	83
5.5.2	Challenges	83
5.5.3	Contribution	85
5.5.4	Results	86
5.6	Querying	88
5.6.1	Workflow	88
5.6.2	Results	89
5.6.3	CSP	93
6	Conclusion	101
6.1	Conclusion	101
6.2	Research Achievements	102
6.3	Discussion	103
6.3.1	ALASKA	103
6.3.2	Expressivity	103
6.3.3	Efficiency	104
6.3.4	Decentralization	104
	List of Figures	113

Introduction

The art and science of asking questions is the source of all knowledge.

T. BERGER

1.1 Introduction and motivation

This thesis presents original research in the field of Knowledge Representation and Reasoning, a central Artificial Intelligence issue.

The contribution of the thesis is providing the ALASKA platform, that is able to integrate under a unified logical framework different implementation approaches for addressing the RULE-BASED DATA ACCESS problem.

Knowledge Representation (KR) is one of the basic issues in Artificial Intelligence (AI) research. In order to create applications that are capable of intelligent reasoning, human knowledge about an application domain has to be encoded in a way that can be handled

by a problem-solving computing process. Representing knowledge inside the machine has proved to be a non-trivial task. The main difficulty is to have a way to constrain and to make *explicit* the intended conceptual models of a KR formalism, in order to facilitate large-scale knowledge integration and to limit the possibility of stating something that is reasonable for the system but not reasonable in the real world [Croitoru, 2006].

In this thesis we are interested in a particular subset of positive, existential fragment of First Order Logic (FOL) expressed using a rule-based language [Calì *et al.*, 2009]. This language can be encoded in several manners and the encoding will impact the efficiency of storage and querying mechanisms of the language. Despite the importance of the task, a throughout analysis of how the language encoding affects storage and querying is non existing in the literature.

The problem addressed in this thesis is the ONTOLOGY-BASED DATA ACCESS problem. The problem consists in, given a knowledge base containing facts and ontological data, and a conjunctive query, to determine whether there is an answer to the conjunctive query in the knowledge base. There are currently two distinct manners to represent ontological data: description logics languages and rule-based languages.

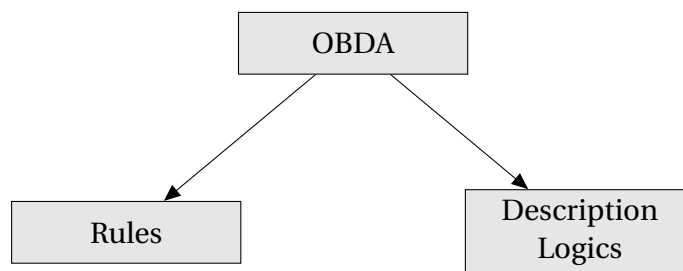

Figure 1.1: Approaches for the OBDA problem.

In this thesis, we will address the problem by representing ontological information through a rule-based language. Such subpart of the problem is also denoted RULE-BASED

DATA ACCESS (RBDA). Please note that in this thesis we will not focus on implementing the rule application algorithms (briefly presented in Section 2), but will rather set up a software architecture (ALASKA) and study then implement all the necessary pre-requirements to make it a rule-based system for reasoning purposes. The integration of rules to the software architecture developed in this thesis is discussed in Section 4.8.

1.2 Research Problem

The motivation behind this work relies on current limitations of existing tools for addressing the RBDA problem from a practical point of view. In this thesis we address the above limitation to show how such practical issues can be addressed. Our contribution proves how:

- To integrate different implementation approaches under the same framework unified by the means of a common logical vision (Chapter 3).
- To provide a generic architecture that communicates to different storage systems through an unified language (Chapter 4)
- To provide higher-level reasoning algorithms on top of the above mentioned architecture and rendering thus independent of the storage used for the data (Chapter 3)
- To provide a practical means for enabling the storage of large knowledge bases on disk avoiding out of memory limitations (Chapter 5)
- To provide a practical means for enabling querying knowledge bases via Constraint Satisfaction methods (Chapter 5)

The research problem we will address in this thesis is: “*How to provide a platform providing under a unified logical framework different implementation approaches for addressing the rule-based data access problem?*”

Our research hypothesis is that such platform can be build by *following the logic based definition of the language (atoms, terms etc) and by dealing with large file storage by the means of buffering and Constrain Satisfaction proof of concept techniques.*

1.3 Thesis structure

In addition to this chapter which provides the context of my research, the thesis contains five chapters.

- Chapter 2 presents the RBDA, by formally defining all the elements of the fragment of First Order Logic we use. The syntax and semantics for facts and rules are presented. Then an overview about the two distinct methods for rule application (forward and backwards chaining) is given, along with the complexity of those techniques. To conclude this chapter, a parallel with other representation languages, such as RDF and Description Logics and our rule-based language is made.
- Chapter 3 describes the evolution of the context of the problem w.r.t the nature of data and storage systems available now. According to this context, the chapter features the study of different available systems and compares them according to the following topics: their ability of representing a knowledge base, performing a conjunctive query on that base, and performing a conjunctive query on the base when its facts are enriched by rules.
- Chapter 4 presents ALASKA, the generic and logic-based software platform we have developed in order to address the RBDA problem. In this chapter, we introduce our

motivations and inspirations upon the design phase of the project. We also detail the multi-layered architecture of the platform. An example of generic algorithm (a backtracking algorithm for homomorphism computing) is given highlighting the use of generic functions implemented by any store connected to ALASKA. The stores featured in this work are then quickly described, followed by an example. After an explanation on how we aim using ALASKA for addressing the RBDA problem, we also discuss the potential use of ALASKA in other domains.

- Chapter 5 features all the experimental work performed throughout this thesis. Algorithms for loading a knowledge base and storing it on disk are given for all the stores connected to ALASKA. Then some of the important generic functions of ALASKA are detailed according to their implementation. After the input data we have used is introduced, the chapter presents the workflows of our efficiency tests on storage and querying. For storage, we present a buffered algorithm for storing a large knowledge base without running out of memory, while in querying we present an adaptation of the problem into a constraint satisfaction problem.
- Chapter 6 concludes the thesis by summarizing the achievements of the thesis. It also presents other future research problems opened by my work.

1.4 Evaluation

This thesis, as a whole, demonstrates that we can provide an architecture able to platform RBDA in a unified logical manner.

Based on this thesis's research hypothesis “*How to provide a platform providing under a unified logical framework different implementation approaches for addressing the rule based data access problem?*”, we will consider this work successful if we can prove

that:

- Different implementation approaches have been integrated under the same framework unified by the means of a common logical vision. This is highlighted in Chapter 3 where we show how the formalism presented in Chapter 2 can be retrieved from all the listed approaches.
- A generic architecture that communicates to different storage systems through an unified language was built. In Chapter 4 we present the ALASKA platform, a software architecture that integrates different storage method by the means of an abstract and logic-based abstract layer.
- The possibility of writing higher-level reasoning algorithms independent of the storage used for the data is granted. This is explained in 4 where the foundations and the architecture of ALASKA is presented. An example of this possibility is explained by presenting the generic backtracking algorithm implemented in ALASKA for homomorphism computing.
- A practical method for storing large knowledge bases on disk avoiding running out of memory was provided. This is presented in Chapter 5 where after explaining a testing workflow, we explain the difficulties that may appear when performing such operation and present a buffered algorithm as a solution.
- A practical method for querying knowledge bases using constraint satisfaction solver is provided. This is also presented in Chapter 5, where we present two transformations of the initial RBDA problem to a constraint satisfaction problem. The two methods presented differ according to the size of the knowledge base one wants to query.

Rule-Based Data Access (RBDA)

A mathematician is a device for
turning coffee into theorems.

P. ERDÖS

2.1 Chapter Overview

In this chapter, we introduce the research problem we address in this thesis, RULE-BASED DATA ACCESS. The chapter starts by a very brief description of the problem (Section 2.2) followed by an example. Sections 2.3 and 2.4 introduce and list the theoretical definitions and properties for a better understanding of the problem. Equivalences between RBDA and other families of languages are discussed in Section 2.5. We conclude the chapter with a short conclusion that resumes the properties and characteristics seen throughout the chapter.

2.2 Foreword

2.2.1 Problem presentation

The RULE-BASED DATA ACCESS (RBDA) problem, derived from ONTOLOGY-BASED DATA ACCESS [Lenzerini, 2002] knows today an interest in knowledge systems allowing for expressive inferences. In its basic form, its input consists in a set of facts, an ontology and a conjunctive query, and the problem consists of finding if answers to the query can be deduced from the facts, eventually using inferences allowed by the ontology. This deduction mechanism could either be done (1) previous to query answering by fact saturation using the ontology (forward chaining) or (2) by rewriting the query according to the ontology and finding a match of the rewritten query in the facts (backwards chaining).

Let us consider a knowledge base F that consists of a set of logical atoms, a set of rules \mathcal{R} written in some (first-order logic) language, and a conjunctive query Q . The RBDA problem stated in reference to the classical *forward chaining* scheme is the following: “Can we find an answer to Q in a database F' that is built from F by adding atoms that can be logically deduced from F and \mathcal{R} ?”

Since forward chaining schemes can unreasonably increase the size of the database (and thus cannot be relied upon when considering very large knowledge bases), some algorithms use a *backward chaining scheme* (or query rewriting) for query answering. In that case, the set of rules \mathcal{R} (and sometimes the database itself F , leading to a complexity increase) is used to build from Q a rewritten query Q' (that is often a disjunction of conjunctive queries), such that there exists an answer to Q in F' if and only if there exists an answer to Q' in F .

There are today two major approaches in order to represent an ontology for the OBDA problem. The first one are the Description Logics. Description Logics are families of languages used for defining concepts. Based upon constructors, the expressivity of the

languages comes from the combination of these constructors. Description Logics allow today for very large expressivity. However, such expressivity is responsible for exponential blow-up when answering conjunctive queries. In order to be able to answer conjunctive queries, people have defined and studied "lite" description logics, which are less expressive but in which conjunctive query answering is decidable (e.g. \mathcal{EL} ([Baader *et al.*, 2005]) and DL-Lite [Calvanese *et al.*, 2007] families).

The second method is to represent the ontology via inference rules. Recent works consider the Datalog⁺ [Calì *et al.*, 2009] language to encode a generalization of Datalog that allows for existentially quantified variables in the head of the rules. Such capacity is also responsible for undecidability when answering conjunctive queries. Works have focused on identifying and developing algorithms for particular fragments of Datalog⁺ that are decidable [Calì *et al.*, 2010; Baget *et al.*, 2011b]. For this reason we will focus on this problem in this work. Later in this chapter, we remind that using rules for encoding the ontology cover the families of "lite" description logics.

While above work focuses on logical properties of the investigated languages, existing approaches employ a less principled approach when implementing such frameworks. It is well known [Abiteboul *et al.*, 1995; Chein et Mugnier, 2009] that encoding such languages can be equivalently done using (hyper)graphs or relational databases. However, none of the existing systems make this possibility of different encodings explicit. The choice of the appropriate encoding is left to the knowledge engineer and it proves to be a crafty task.

2.2.2 Example

Let us describe RBDA by the means of an example. In the following, we consider the case of a very simple knowledge base represented by some facts and an ontology. The knowledge base we take for example contains the following facts:

- (a) Paris, Montpellier and Nîmes are cities.

- (b) Alice is a woman, and Bob is a man.
- (c) Alice and Bob are friends.
- (d) Alice lives and works in Paris.
- (e) Alice works as a computer analyst.
- (f) Bob lives in Montpellier, and works in Nîmes.
- (g) Bob works as a school teacher.

The knowledge base is also composed of the following rules:

1. "A school teacher teaches Latin."
2. "A computer analyst knows programming."
3. "If a person lives in Montpellier and works in Nîmes, then it drives to work."

Let us consider the conjunctive query "*Does someone lives in Montpellier?*". Such query does not require any use of the information in the ontology to be answered, since all the information contained in the facts is already enough to say that Bob lives in Montpellier. On the other hand, queries such as "*Is there anyone that drives to work?*" or "*Is there anyone living in Paris that knows programming?*", does have answers as well, but those can not be found until the information located in the ontology is consulted by the query engine.

As previously stated, consulting the ontology information can either be done via forward or backwards chaining. In a forward chaining algorithm, new information is added to the facts when rules may apply on the current facts. The algorithm checks if there is new information to be added according to the facts and rules. According to rule 1, (h) "Bob teaches Latin" is a new fact added to the knowledge base. Rule 2 adds (i) "Alice knows programming" and rule 3 adds (j) "Bob drives to work" to the knowledge base. As no new information can be obtained by rule application, we say that the facts are saturated. The

question “*Is there anyone that drives to work?*” has now an answer in the facts and can be answered successfully.

On the other hand, a backwards chaining algorithm does not alter the facts but does rewrite queries according to the ontology content. For the “*Is there anyone living in Paris that knows programming?*” question, the algorithm looks for different manners to rewrite the original query based on the rules. From the different possible rewritings, the query “*Is there anyone living in Paris that is a computer analyst?*” is obtained according to rule 2 (“a computer analyst knows programming”) in the ontology. We see that this newly obtained query has an answer in the facts. The answer for this rewriting is an answer to the initial query.

2.3 Facts

2.3.1 Syntax

The syntax of the logical language we use is the following: we consider constants but no other functional symbols. In order to represent a knowledge base, a vocabulary has to be defined. A vocabulary W is composed of a set of predicates P and a set of constants C . Constants are tokens that identify the individuals in the knowledge base, while predicates represent relations between such individuals. We also consider X , a set of variables in the knowledge base.

Definition 2.1 (Vocabulary) *Let C be a set of constants and P a set of predicates. A vocabulary is a pair $W = (P, C)$ and arity is a function from P to \mathbb{N} . For all $p \in P$, $\text{arity}(p) = i$ means that the predicate p has arity i .*

We will also consider an infinite set X of variables, disjoint from P and C . Hence, an atom on W is of form $p(t_1, \dots, t_k)$, where p is a predicate of arity k in W and the t_i are constants in W or variables. A term is an element of $C \cup X$. For a given atom A , we note

$\text{terms}(A)$, $\text{csts}(A)$ and $\text{vars}(A)$ respectively the terms, constants and variables occurring in A .

Definition 2.2 (Fact) *A fact is a finite, but possibly empty, set of atoms on a vocabulary. For a given fact F , we note $\text{atoms}(F)$ the atoms occurring in F .*

Example Let us consider a vocabulary $W = (P, C)$. $P = \{\text{man}, \text{woman}\}$, $C = \{\text{Bob}, \text{Alice}\}$ and $\text{arity} = \{(\text{man}, 1), (\text{woman}, 1)\}$. $\text{man}(\text{Bob})$ and $\text{woman}(\text{Alice})$ are two distinct atoms on W , and $F = \{\text{man}(\text{Bob}), \text{woman}(\text{Alice})\}$ is a fact on W .

2.3.2 Semantics

Definition 2.3 (Interpretation) *Let $W = (P, C)$ be a vocabulary. An interpretation of W is a pair $I = (\Delta, \cdot^I)$ where Δ is the domain of the interpretation, and \cdot^I a function where: $\forall c$ in C , $c^I \in \Delta$ and $\forall p$ in P , $p^I \subseteq \Delta^{\text{arity}(p)}$.*

An interpretation is non empty and can be possibly infinite.

Definition 2.4 (Model) *Let F be a fact on W , and $I = (\Delta, \cdot^I)$ be an interpretation of W . We say that I is a model of F iff there exists an application $\nu : \text{terms}(F) \rightarrow \Delta$ (called a justification of F in I) such that:*

- $\forall c \in \text{csts}(F)$, $\nu(c) = c^I$ and
- $\forall p(t_1, \dots, t_k) \in \text{atoms}(F)$, $(\nu(t_1), \dots, \nu(t_k)) \in p^I$.

Definition 2.5 (Fact to logical formula) *Let F be a fact. $\phi(F)$ is the logical formula that corresponds to the conjunction of atoms in F . And $\Phi(F)$ corresponds to the existential closure of $\phi(F)$.*

Example Let us consider a fact $F = \{\text{person}(x), \text{name}(x, \text{Bob}), \text{age}(x, 25)\}$.

- $\phi(F) = \text{person}(x) \wedge \text{name}(x, \text{Bob}) \wedge \text{age}(x, 25)$.
- $\Phi(F) = \exists x \text{person}(x) \wedge \text{name}(x, \text{Bob}) \wedge \text{age}(x, 25)$.

Property 2.1 (Model equivalence) *Let F be a fact and I be an interpretation of \mathcal{W} . Then I is a model of F iff I is a model (in the FOL sense) of $\Phi(F)$.*

Definition 2.6 (Entailment) *Let F and G be two facts, F entails G if every model of F is also a model of G . The entailment relation is then noted $F \models G$.*

2.3.3 Computing

Definition 2.7 (Homomorphism) *Let F and F' be facts. Let $\sigma: \text{terms}(F) \rightarrow \text{terms}(F')$ be a substitution, i.e. a mapping that preserves constants (if $c \in C$, then $\sigma(c) = c$). We then note $\sigma(F)$ the fact obtained from F by substituting each term t of F by $\sigma(t)$. Then σ is a homomorphism from F to F' iff the set of atoms in $\sigma(F) \subseteq F'$.*

Example Let $F = \{\text{man}(x_1)\}$ and $F' = \{\text{man}(\text{Bob}), \text{woman}(\text{Alice})\}$. Let $\sigma: \text{terms}(F) \rightarrow \text{terms}(F')$ be a substitution such that $\sigma(x_1) = \text{Bob}$. Then σ is a homomorphism from F to F' since the atoms in $\sigma(F)$ are $\{\text{man}(\text{Bob})\}$ and the atoms in F' are $\{\text{man}(\text{bob}), \text{woman}(\text{Alice})\}$.

Property 2.2 (Entailment) *Let F and Q be facts. $F \models Q$ iff there exists Π an homomorphism from Q to F .*

2.3.4 Complexity

The entailment problem is a NP-Complete problem. However, there exist polynomial cases of the problem, such as when Q has a tree structure. See [Chein et Mugnier, 2009; Croitoru et Compatangelo, 2006] for polynomial subclasses.

2.4 Rules

2.4.1 Syntax

Rules are objects used to express that some new information can be inferred from another information. Rules are built upon two different facts, and such facts correspond to the two different parts of a rule, called head and body. Once the body of a rule can be deduced from a fact, then the information in the head should also be considered when accessing information.

Definition 2.8 (Rule) *Let H and B be facts. A rule is a pair $R = (H, B)$ of facts where H is called the head of the rule and B is called the body of the rule. A rule is commonly noted $B \rightarrow H$.*

2.4.2 Semantics

Definition 2.9 (Rule model) *Let W be a vocabulary, I an interpretation on W , and R a rule on W . We say that I is a model of R iff for every justification V_B of B in I there exists a justification V_H of H in I such that $\forall t \in \text{vars}(B) \cap \text{vars}(H), V_B(t) = V_H(t)$.*

Definition 2.10 (Rule to logical formula) *Let $R = (H, B)$ be a rule. Let b_x be the variables from B , and h_x be the variables from H that are not in B , the logical formula corresponding to R is the following: $\Phi(R) = \forall b_x (\phi(B) \rightarrow \exists h_x \phi(H))$.*

Example Let us consider a rule $R = \{\text{person}(x), \text{person}(y), \text{sibling}(x, y)\} \rightarrow \{\text{person}(z), \text{parent}(x, z), \text{parent}(y, z)\}$. $\Phi(R) = \forall x, y (\text{person}(x) \wedge \text{person}(y) \wedge \text{sibling}(x, y) \rightarrow \exists z \text{person}(z) \wedge \text{parent}(x, z) \wedge \text{parent}(y, z))$.

Property 2.3 (Model equivalence) *Let R be a rule and I be an interpretation of W . Then I is a model of R iff I is a model (in the FOL sense) of $\Phi(R)$.*

Definition 2.11 (Knowledge base) *Let W be a vocabulary. A knowledge base (KB) is a pair $K = (F, \mathcal{R})$ where F is a fact on W and \mathcal{R} is a set of rules on W .*

Definition 2.12 (KB model) Let $K = (F, \mathcal{R})$ be a knowledge base and I be an interpretation. I is a model of K iff I is a model of F and also a model of every rule R_i in \mathcal{R} .

Definition 2.13 (Entailment) Let K be a knowledge base and Q be a fact. K entails Q iff all models of K are also models of Q .

The RULE-BASED DATA ACCESS is defined as the following:

Algorithm 1: Rule-Deduction

Input: K a knowledge base, Q a fact

Output: TRUE if all the models of K are also models of Q

Definition 2.14 (Logical representation of a knowledge base) Let $K = (F, \mathcal{R})$ be a knowledge base. $\Phi(K) = (\Phi(F), \Phi(\mathcal{R}))$ is the logical representation of K . $\Phi(F)$ is the logical formula of F and $\Phi(\mathcal{R}) = \bigcup_{r \in \mathcal{R}} \Phi(r)$.

Property 2.4 (Model equivalence) Let K be a knowledge base and I be an interpretation. Then I is a model of K iff I is a model (in the FOL sense) of $\Phi(K)$.

In other words, given a knowledge base K and a conjunctive query Q , the RBDA problem consists in answering if Q can be deduced from K , denoted $K \models Q$.

2.4.3 Algorithms

Rule application can be performed of two different methods, called FORWARD CHAINING and BACKWARDS CHAINING.

Forward chaining

Definition 2.15 (Applicable rule) Let $R = (H, B)$ be a rule and F be a fact. R is applicable to F if there exists an homomorphism $\Pi : B \rightarrow F$. In this case, the application of R to F according to Π is a fact $\alpha(F, R, \Pi) = F \cup \Pi^{\text{safe}}(H)$.

Please note the use of Π^{safe} instead of Π . Π^{safe} is an application that converts existential variables into fresh ones at the moment of joining new information with the initial fact. Such process is important in order to avoid unnecessary specializations. A derivation is the result of a finite sequence of rules application.

Definition 2.16 (Derivation) *Let F be a fact. F' is a derivation of F iff there exists a finite sequence of facts $F = F_0, \dots, F_k = F'$ (called the derivation sequence) such that for every i there exists R and Π such that $F_i = \alpha(F_{i-1}, R, \Pi)$.*

Definition 2.17 (Saturation) *Let F be a fact and R be a set of rules. $\Pi_R(F) = \{\Pi: B_R \rightarrow F\}$ is the set of homomorphisms of the body of applicable rules to F . $\alpha(F, R) = F \cup_{\pi \in \Pi_R(F)} \pi^{\text{safe}}(H_R)$ is the result of the application of all those rules. The saturation of a fact is the process of applying rules from the initial fact until no more new information can be added to the fact via rule application. Let the initial fact $F_0 = F$, and $F_i = \alpha(F_{i-1}, R)$, a fact is saturated when $F_i \equiv F_{i+1}$.*

Theorem 2.1 (Equivalence) *Let $K = (F, R)$ be a knowledge base and Q be a fact. The following assertions are all equivalent:*

- $K \models Q$
- *there exists a derivation $F \dots F'$ such that $F' \models Q$*
- *there exists an $n \in \mathbb{N}$ such that $F_n, R \models Q$*

Backwards chaining

As opposed to forward chaining which enriches the facts with the rule application, the backwards chaining rewrites the initial query in a union of several new queries. The decomposition is obtained by applying rules on the query, i.e. by seeing which rule could have generated the query and from which fact. All possibilities are kept and further decomposed until the initial set of facts is reached or all possibilities are examined. The backwards chaining approach does not enrich the facts but works on the query.

One of the motivations of the ALASKA features is the big addition of facts due to forward chaining rule application. This is the reason why in this work we do not focus on backwards chaining. In the following we will simply define what a backwards chaining decomposition is and then the reader is invited to further consult works cited below on backwards chaining.

Definition 2.18 (Backwards chaining) *Let Q be a fact and R a set of rules. We denote $B(Q, R) = \{Q_i \mid \forall F, (F, R) \models Q \text{ iff } \exists Q_i \in B(Q, R) \text{ such that } F \models Q_i\}$.*

The work of [Salvat et Mugnier, 1996], corrected by [Baget et Salvat, 2006], and adapted to First Order Logic in [Baget *et al.*, 2011a] provides such a rewriting.

2.4.4 Complexity and decidability

The complexity of RBDA may vary according to the set of rules present in the ontology. When there are no rules in the ontology, the problem is then equivalent to homomorphism computation, which is a NP-complete problem.

In the presence of rules, the problem is undecidable. Both the forward chaining and backwards chaining mechanisms are not certain of halting. This is easy to verify through the means of very simple examples.

Forward chaining Let $K = (F, R)$ be a knowledge base, $F = \text{person}(\text{Bob})$, and $R = \{\{\text{person}(x)\} \rightarrow \{\text{parent}(y, x), \text{person}(y)\}\}$.

Let $Q = \{\text{parent}(x, \text{Tom})\}$ be a fact. Asking a forward chaining mechanism if Q can be deduced from K may eventually never stop. The mechanism will first verify if Q can be deduced from F , if there is an x having Tom as parent in F . As it is not the case, rules will be applied and F will be enriched into $F' = \{\text{person}(\text{Bob}), \text{parent}(p_1, \text{Bob}), \text{person}(p_1)\}$. The mechanism will then verify if Q can be deduced from F' . As it is still not the case, it will once again apply rules and enrich F' into F'' . And it will do it infinitely as in this case,

no answer will be ever found to the query.

Backwards chaining Let $K = (F, R)$ be a knowledge base, and $R = \{p(x, y), p(y, z)\} \rightarrow \{p(x, z)\}$.

Let $Q = \{p(a, b)\}$ be a fact. Asking a backwards chaining mechanism if Q can be deduced from K may also eventually never stop. The mechanism will first verify if $\{p(a, b)\}$ can be deduced from F . If that is the case, the mechanism will stop. Otherwise, it will rewrite the initial query Q into a new query $Q_1 = \{p(a, x_0), p(x_0, b)\}$. Q is deduced from K if Q_1 is deduced from K . If Q_1 can not be deduced from F , the mechanism will rewrite the query again, for example with $Q_2 = \{p(a, x_0), p(x_0, x_1), p(x_1, b)\}$. Such sequence of rewritings may never end. Any finite rewriting corresponds to a finite sequence, for example, of length k of form $\{p(a, x_0) \dots p(x_k, b)\}$. The facts could always contain a sequence of length $k + 1$.

Works [Baget *et al.*, 2010] have identified classes of rules in which the RBDA problem is decidable. One of those is the class of Range-Restricted rules. Such class does only contain rules in which no existential variable is present in the head of the rule, in other words, when no new variable is created upon rule application. They are part of the Finite Expansion Set class, a class in which the saturation process is finite. Another classes of rules in which the problem is decidable are the FUS (Finite Unification Sets) and BTS (Bounded Treewidth Sets) classes. The rules of BTS class have the particularity of generating and infinite fact with an arborescent structure, while the ones in FUS have the particularity of generating a finite sequence of query rewritings. See [Thomazo, 2013] for further details. Those classes will appear once again in the next section, where a comparison between RBDA and other languages will be established.

2.5 Other languages

As stated earlier in this chapter, representing an ontology by the means of rules covers different other languages. In this section, the cases of RDF and "lite" Description Logics are treated. Without getting very deep in details, we present those languages and, through the means of examples, we demonstrate how it is possible to convert the existing problems of those languages into RBDA.

2.5.1 RDF

RDF is a data model introduced by the W3C [Klyne *et al.*, 2004] in order to describe formally resources and their metadata. An advantage of RDF, which is one the reasons of its success is the simplicity to describe entities/resources in the model. Currently the model is widely used to describe web resources, which makes RDF one of the founding bricks of the Semantic Web development [Hitzler *et al.*, 2011].

RDF data model is based upon the idea of describing resources through the means of statements. A statement is a triple, composed of a subject representing the resource (concept or individual) to describe, a property, representing a relation associated to the subject, and an object, which is the value associated to the property. Blank nodes can also be used to represent an unidentified resource. An object can either be raw data (number, string), another resource, or a blank node. A set of RDF statements represents a labeled and oriented multigraph. RDF syntax is the following:

- A RDF document is composed of a set of triplets $t = (s,p,o)$, where s is the subject, p the property and o the object.
- The subject of a triplet is either a resource identified by an URI either a blank node.
- The property of a triplet is a resource identified by an URI.
- The object of a triplet can either be a resource identified by an URI, either a blank node, or raw data.

Definition 2.19 (Triplet to atom) Let $t = (s, p, o)$ be a triplet. $\Phi_{\text{RDF}}(t)$ is the atom corresponding to the triplet such that $\Phi_{\text{RDF}}(t) = \text{pred}(s, p, o)$. In our formalism, s and o are variable terms if they are blank RDF nodes. If not, they are constant terms.

Definition 2.20 (RDF to fact) Let R be a RDF document. $\Phi_{\text{RDF}}(R) = \{\Phi_{\text{RDF}}(t) \mid t \in R\}$.

Example Let us consider the following RDF document R :

```
_:x rdf:type foaf:Person.
_:x foaf:name "Bob".
```

The corresponding fact to the RDF document is $\Phi_{\text{RDF}}(R) = \{\text{pred}(x, \text{rdf} : \text{type}, \text{foaf} : \text{Person}), \text{pred}(x, \text{foaf} : \text{name}, \text{"Bob"})\}$.

Property 2.5 (Simple entailment) Let R_F and R_Q be RDF documents. $R_F \models R_Q$ iff $\Phi_{\text{RDF}}(F) \models \Phi_{\text{RDF}}(Q)$. We say that R_F simply entails R_Q .

This property is detailed here [Baget, 2005]. The semantics of RDF and RDFS, based on semantic rules, can easily be implemented in a rule-based ontology. We show it below through an example.

Example We will use rule `rdfs8` of [Hayes, 2001] as example. Let `xxx`, `yyy` and `zzz` be resources identified by URI. In Stage 3 of the `rdfs-closure` computing, it is stated that the presence of `xxx [rdfs:subClassOf] yyy` and `yyy [rdfs:subClassOf] zzz` in the document lead to the add of `xxx [rdfs:subClassOf] zzz` to the original document.

This semantic rule can be translated into the following rule in our scope: $\{\text{pred}(x, \text{rdfs} : \text{subClassOf}, y), \text{pred}(y, \text{rdfs} : \text{subClassOf}, z)\} \rightarrow \{\text{pred}(x, \text{rdfs} : \text{subClassOf}, z)\}$.

Such rule is Range-Restricted as it does not feature any existential variable in the head of the rule. All the rules obtained through the transformation of RDF and RDFS semantic rules are Range-Restricted, which makes it a decidable case of RBDA. [Baget, 2005] defines RDF entailment as the entailment of a RDF document into another, potentially enriched

by the RDF entailment rules. This also applies to RDFS with the RDFS entailment rules. We denote \mathcal{R}_{RDF} a set of rules that encodes the RDF entailment rules, and $\mathcal{R}_{\text{RDFS}}$ a set that encodes RDFS entailment rules. Both RDF and RDFS rules are detailed in [Hayes, 2004].

Property 2.6 (RDF Entailment) *Let R_F and R_Q be RDF documents. $R_F \models_{\text{RDF}} R_Q$ iff $\Phi_{\text{RDF}}(F), \mathcal{R}_{\text{RDF}} \models \Phi_{\text{RDF}}(Q)$.*

Property 2.7 (RDFS Entailment) *Let R_F and R_Q be RDF documents. $R_F \models_{\text{RDFS}} R_Q$ iff $\Phi_{\text{RDF}}(F), \mathcal{R}_{\text{RDF}} \cup \mathcal{R}_{\text{RDFS}} \models \Phi_{\text{RDF}}(Q)$.*

Please note that through this document, we will not work directly with RDF entailment, but the RDF language will be featured in other chapters of the document, as it has been used for the acquisition of large amount of data and also in the study of storage systems.

2.5.2 Description Logics

As previously said in this chapter, encoding the content of an ontology can also be done through description logics. RBDA does not systematically covers all the description logic languages: some of them allow different expressivity. Others can easily be transformed into existential rules. In this section, we will have a closer look into a group of description logics, the "lite" DLs. Such languages feature limited expressivity, but ensure the decidability of the deduction mechanisms. Lite DLs are almost entirely covered by RBDA.

The \mathcal{EL} family of description logics

As for RDF, we will show how a problem represented in \mathcal{EL} can be transformed in a RBDA instance through an example using the \mathcal{ELH}_\perp language. This language features the following constructors: \top , \perp , C , $C \sqcap D$ et $\exists R.C$. It also features domain and range for relations.

The assertions of type $C \sqsubseteq D$ can be translated into existential rules. For instance, the following assertion $C \sqcap \exists R.C \sqsubseteq \exists S.(D \sqcap E)$ is equivalent to this rule: $\{C(x), r(x, y), C(y)\} \rightarrow$

$\{S(x, y'), D(y'), E(y')\}$. The presence of the \perp constructor adds a negative constraint (C_{\perp}) to the entailment computing. The presence of this constraint however does not bring any change at decidability level.

Property 2.8 (\mathcal{EL} Entailment) *Let $K = (A, T)$ be a knowledge base and let Q be a query. $A, T \models_{\mathcal{EL}} Q$ iff $A, \Phi(T), \{C_{\perp}\} \models Q$.*

Using this translation into rules, all the new rules will generate facts with a tree structure. That property ensures the decidability of the rule application mechanism in this case [Baget *et al.*, 2011a].

DL-Lite family

Another family of "lite" description logics is DL-Lite family. Like \mathcal{EL} , DL-Lite family is also decidable and can also be almost entirely covered by RBDA. The elements of such languages that can not be represented by rules are the possibility of using functional values, and also assertions of the type: $A \sqsubseteq \neg C$, that would imply a negative constraint $\neg(A \wedge C)$.

DL-Lite family also introduces Equality-Generating Dependencies (EGD). In logics, such rules would be of type $\{R(x, y), R(x, y')\} \rightarrow \{y = y'\}$, when the result of the rule application implies the equivalence between two terms.

2.6 Conclusion

As we have stated earlier, RBDA is a sub-problem of OBDA where the ontology is encoded using rules. As we have seen in this chapter, the choice of language for ontology representation is very important, as the decidability of the algorithms depends on it. In this work, we have chosen to represent the ontology via rules. The reason of this choice comes from the expressivity of rule-based languages and also the fact that it can be defined as a generic formalism for other ontology representations. Both expressivity and genericity

arguments are put forward in the previous section, where we have highlighted how RBDA covers in a generic way other languages for ontology encoding.

Tools for RBDA

A prudent question is one-half of wisdom.

F. BACON

3.1 Chapter Overview

In this chapter, an overview of the current context of the `RULE-BASED DATA ACCESS` problem is given. Such context defines the nature and the volume of data we perform reasoning on. Previously, a few different solutions to address conjunctive query answering problems have existed, and the first step of this work of designing a generic software architecture is to study such previous solutions, identifying their strengths and drawbacks in order to have a clearer idea on how to proceed in order to address large and semi-structured knowledge bases.

Section 3.2 describes the evolution of the nature of the problem according to different factors, and Section 3.3 explains the motivation of this thesis by presenting the novelty aspects of the work and how we pretend address the problem. Section 3.4 describes

Prolog [Clocksin et Mellish, 1994], a logic programming language introduced in the early 1970s. Section 3.5 details classic relational databases, while Sections 3.6 and 3.7 present two graph-based approaches for addressing the problem: CoGITaNT [Genest et Salvat, 1998] and the recent Graph Databases [Robinson *et al.*, 2013]. We close this chapter bringing a brief discussion on the methods and system previously presented and the manner we expect those could fulfill our needs.

3.2 Problem Evolution

Derived from the ONTOLOGY-BASED DATA ACCESS problem, RBDA knows today a totally renewed interest due to the recent evolutions in the KR and in the Information Technology (IT) field in general. Information sources have become larger and larger, reaching sizes that one can not load entirely in a system's main memory. Information has also become more and more semi-structured [Abiteboul, 2009], which leads to a different challenge according to the manner one intends to query a knowledge base. Such emergence of semi-structured knowledge bases has led to the emergence of non-relational database models that fit best such kind of information structure.

3.2.1 Large KBs

It is very difficult not to see in the current context the continuous growth of the size of datasets. BigData popularity has now become important, not only in the industrial scope but also in the academic scope. Domains such as social networks and Semantic Web are responsible for the emergence and treatment of a very large quantity of data. It is sometimes difficult to quantify the sizes of certain of those knowledge bases. In academia, projects such as DBPedia¹, UniProt² and GeoNames³ are well known for having very large amount of information. A consequence of such increase in the size of the data sources is also the emergence of the XLDB acronym, for eXtremely Large Databases, in order to

1. <http://dbpedia.org>

2. <http://www.uniprot.org/>

3. <http://www.geonames.org/>

replace/complete the former VLDB one (for Very Large Databases).

In the whole document, we consider as large, every knowledge base that can not be entirely loaded in main memory when an application is run. Our work will focus only in knowledge bases stored on disk and accessible via reading and writing interfaces.

3.2.2 Semi-structured

Semi-structured data is data that is not raw data, neither data structured according to well defined schema. In [Abiteboul, 2009], several types of semi-structured data are described. Most of the large data sources cited above contain a large amount of semi-structured data, known for their evolutive or undetermined schema. Are also part of semi-structured data the data in which it is impossible (or at least very hard) to dissociate the schema from the data itself.

This kind of data is currently very widely spread inside Open Data, Linked Data [Bizer *et al.*, 2009] and data mining fields, where the integration of heterogeneous data sources is often needed. Classical relational databases have already shown limited efficiency when dealing with those kind of data. The emergence of databases based upon different data models introduces a new interest in verifying whether those new databases are most suited for semi-structured data than the classic (relational) one.

3.2.3 NoSQL

The idea of NoSQL was born around 1996 when Carlo Strozzi, unhappy with the performances of relational databases has started developing a database management system that would be based upon the relational model of Codd, but in which the querying would not be performed via an SQL interface (hence the NoSQL name). This project was finally a failure, and, when it was discontinued, Strozzi stated that the performance issues he blamed on the databases at that time was not related to the querying interface itself, but

rather to Codd's relational model [Codd, 1970].

A few years later, several databases appeared using different data models. The NoSQL movement is considered today as the regroupment of many database management systems using a data model other than Codd's relational model. Because of that, the question of the use of SQL as querying interface is not even major anymore, as some of those management systems does not feature a SQL interface, and other feature it along with another querying mechanism. In the list of the most known elements of NoSQL, one will find the column-oriented databases, document-based databases, XML databases and graph databases.

3.3 Novelty and motivation

After having defined the technical characteristics and challenges of the problem, we are able to set as a goal to obtain a system that would be able to perform conjunctive queries over knowledge bases of any size and of any structure. Those knowledge bases could be stored in main memory but the case we intend to focus on is when the knowledge base is located in a secondary device. In order to reach that goal, we will first study the approaches and methods that already exist for storing and querying information. The study of those systems will be based on their ability to answer the following questions:

1. - Can it be used for representing a knowledge base in our formalism?
2. - Can it be used for computing entailment?
3. - Can it be used for computing entailment with rule application?

The following sections of this chapter will introduce each of the systems studied and present their characteristics according to the questions above. Answers will be followed by examples to illustrate how our formalism can be retrieved from the internal representation

of each system.



Figure 3.1: Example: Scene cut from Tintin movie, featuring Tintin and the Duponts.

Figure 3.1 is the image selected for the examples. It presents a scene from the latest Tintin movie. The information we have extracted from the image is the following:

- $F = \{\text{next-to}(D1, D2), \text{next-to}(D2, T), \text{reads}(D1, N), \text{reads}(D2, N), \text{reads}(T, N), \text{dressed-in}(D1, \text{black}), \text{dressed-in}(T, \text{blue})\}$
- $R = \{\{\text{same-suit}(X, Y), \text{dressed-in}(X, Z)\} \rightarrow \{\text{dressed-in}(Y, Z)\}\}$
- $Q = \{\text{next-to}(X, Y), \text{reads}(X, Z), \text{reads}(Y, T), \text{dressed-in}(X, \text{black}), \text{dressed-in}(Y, \text{blue})\}$

One should notice that the query Q does not have an answer in F unless it is enriched by R .

3.4 Prolog

Prolog [Clocksin et Mellish, 1994] is a general purpose, declarative, logic programming language. The program logic is expressed in terms of relations, and represented as facts and rules. Computations are initiated by running a query over these relations. The language was first conceived by a research group in Marseille, France, in 1970, led by Alain Colmerauer. The first Prolog system was developed in 1972 by Colmerauer with Philippe Roussel.

3.4.1 Loading a knowledge base

It is very simple to represent a knowledge base according to our formalism in Prolog. Prolog syntax is wider than the elements needed for our representation.

In Prolog, program logic is expressed in terms of relations, and a computation is initiated by running a query over these relations. A fact in Prolog is what we consider an atom in our notation. The following assertion is a fact in Prolog.

```
color(black).
```

As the syntax are much alike, the line represents the `color(black)` atom. Prolog syntax rules indicate that `black` is a constant term. Variables exist natively in Prolog and those are terms that have their first letter in upper-case.

As a fact is a set of atoms, it can be represented by multiple lines of Prolog facts. The following Prolog program represents a fact.

```
next-to(D1,D2).  
next-to(D2,T).  
reads(D1,N).  
reads(D2,N).  
reads(T,N).
```

```
dressed-in(D1,black).
dressed-in(T,blue).
```

Such program represents the fact F . It could also be interpreted as seven different atoms, $\text{next-to}(D1,D2)$, $\text{next-to}(D2,T)$, $\text{reads}(D1,N)$, $\text{reads}(D2,N)$, $\text{reads}(T,N)$, $\text{dressed-in}(D1,black)$, $\text{dressed-in}(T,blue)$. This is not a problem as the union of two (or more) facts is also a fact.

The Prolog syntax for rules differs a bit from our formalism. The head of the rule comes first, followed by the body. By this definition, the rule R previously presented is represented as the following in Prolog:

```
dressed-in(Y,Z) :- same-suit(X,Y), dressed-in(X,Z).
```

A rule with an empty body is equivalent to the fact of the head of the rule. Also, one important thing to notice is that Prolog does not allow the presence of existential variables in the head of the rule. All the variables of the head must also appear in the body of the rule. However, the skolem form of such a rule could be written since Prolog handles function symbols.

3.4.2 $F \models Q$ and $F, \mathcal{R} \models Q$

Computing entailment is made in Prolog by querying the information previously entered in the program. A query is a fact, therefore queries are constructed using the same format as facts. Hence, the command:

```
?- next-to(X,Y), reads(X,Z), reads(Y,T), dressed-in(X,black), dressed-
in(Y,blue).
```

will call the reasoning engine to determine whether the query Q can be deduced from

the facts and the rules present in the program. As Prolog features rules natively, its reasoning mechanism handles the rule application process while processing the query.

The reasoning method it uses is called SLD resolution (Selective Linear Definite clause resolution). Given a query, the engine attempts to find a refutation of the negated query. If the negated query can be refuted, (i.e., an instantiation for all free variables is found that makes the clauses of the negated query false), it follows that the original query, with the found instantiation applied, is considered a logical consequence of the program. And thus that the program, containing F and \mathcal{R} entails Q .

Prolog has a major drawback in the fact that it is a main memory only computation process. Which means that it has to load the whole information of facts and rules in main memory before starting answering queries. As we have previously stated, this behaviour limits our interest in using it for implementing RBDA over large and semi-structured knowledge bases.

3.5 Relational databases

The relational model for the management of databases has been formulated by Codd in 1969. In this model, data is represented by tuples, regrouped into relations. This regroupment of relations is called a schema. The goal of the relational model was to provide a declarative method to specify data and the queries on that data. It introduces then a separation between the user, that indicates which information the database must contain et which content he wants to access, and the database management program that is in charge of the operations of access to the internal data structure and the algorithms of search in order to satisfy the users requests.

3.5.1 Loading a knowledge base

As previously stated, in a relational database, data is organized by relations. Such relations can be considered as predicates in a vocabulary. The tuples of a relation correspond to an atom, where the predicate is the relation and each element of the tuple is one of atom's terms. The union of all the atoms obtained that way from all the relations of the database is a fact.

next-to	
t ₁	t ₂
d1	d2
d2	t

reads	
t ₁	t ₂
d1	n
d2	n
t	n

dressed-in	
t ₁	t ₂
d1	Black
t	Blue

same-suit	
t ₁	t ₂
d1	d2

Figure 3.2: Relational database corresponding to the fact in the example.

Figure 3.2 illustrates the instance of relational database corresponding to the fact F .

Relational databases does not represent rules natively. Deductive databases are relational databases that are able to make deductions by the introduction of the notions of facts and rules. Most deductive databases use the Datalog language in order to represent those. Datalog is a subset of Prolog and they share the same syntax.

3.5.2 $F \models Q$

Most (if not all) relational databases today feature a native SQL interface for adding new information to the database and also for querying that information. The SQL language is based upon the relational algebra, a language having the expressivity of First Order Logic [Abiteboul *et al.*, 1995]. However the implementations of SQL interfaces available today implement a slightly modified version of the relational algebra. In those versions, the relations are represented by tables, and the attributes of the relation are the columns of the relation table. The data contained in the tuples of a relation become then the lines of

this table. The union of all tables represents the whole database.

SQL syntax does provide different features when querying data, however it is possible to extract a fact from a simple SQL query, or from a query stripped from the elements that are not covered in our formalism. Executing the following SQL query statement to the database is equivalent to try to deduce Q from the facts of the database.

```
SELECT * FROM next-to, reads r1, reads r2, dressed-in d1, dressed-in d2 WHERE
next-to.t1 == r1.t1 AND next-to.t2 == r2.t1 AND next-to.t1 == d1.t1 AND d1.t2 == 'black'
AND next-to.t2 == d2.t1 AND d2.t2 == 'blue';
```

Renaming tables corresponding to the predicates that appear twice or more in the query is mandatory in order for the system to properly identify the solutions according to the atoms of the query. Work done further will lead us to write an algorithm for translating a fact in a SQL query statement. Performing the opposite translation requires knowing the name of the attributes of the relations in order to generate a correct query.

It is also possible to avoid the use of an SQL interface for answering conjunctive queries in a relational database. Another solution is to write an homomorphism computing algorithm that reads the atoms and terms informations directly from the database. In order to do so, all the calls to the methods that read the knowledge base (such as finding possible matchings for a term or verifying if an atom is in the database) need to be performed via SQL statements that would obtain the same answers from the relational database management system.

3.5.3 $F, \mathcal{R} \models Q$

As previously stated, relational databases does not support rules natively, requiring the presence of another language in order to define rules. A common language for this is the Datalog language, which is a subset of the Prolog language. A major drawback of Datalog

is that it only supports rules with no existential variables in the head of the rule, meaning that no new terms can be added to the knowledge base by rule application. In a forward chaining process, this makes no possibility of enriching a fact with ontological knowledge without implementing it from scratch. Such work will not be featured in this thesis. Details about it will be given in section 4.8.

3.6 CoGITaNT

CoGITaNT is a platform that implements the full model of Conceptual Graphs. Conceptual Graphs [Sowa, 1976] are a data model that represent information by the means of concepts, individuals, and relationships between concepts. CoGITaNT is an evolution of CoGITo (Conceptual Graphs Integrated Tools) [Guinaldo et Haemmerlé, 1997], a software architecture first designed and created by Ollivier Haemmerlé. CoGITo first versions did only feature simple conceptual graphs (corresponding to F and a set of rules R expressing concept and relation type hierarchies). In 1997, it was renamed to CoGITaNT with the appearance of rules, typed nested graphs and co-reference links. CoGITaNT stands for CoGITo allowing Nested Typed graphs. Since then, David Genest has been responsible of the maintenance of the library.

CoGITaNT has had success enabling developers to manage graphs and perform several graph operations to them, such as general graph homomorphism, tree query graph homomorphism, maximal join and rule application. It is developed in C++ and the operations are performed by loading the graph(s) to be managed directly in main memory. The conceptual Graphs model is implemented as a graph structure (where nodes denote the concepts or the relations and the edges denote the links between them).

3.6.1 Loading a knowledge base

The fragment of Conceptual Graphs we are interested in are simple conceptual graphs enriched by rules. Type and relation hierarchy will be considered, while nested graphs will not. From the conceptual graph into our formalism, the concept types become unary predicates and individuals become constants in the vocabulary. The conceptual graph in Figure 3.3 represents the fact F . Note that Conceptual Graphs rely upon a typed version of FOL (all terms are given a type, which is an unary predicate). Since no such type is provided in our example, all terms (i.e. nodes in the graph) have been given the universal type \top .

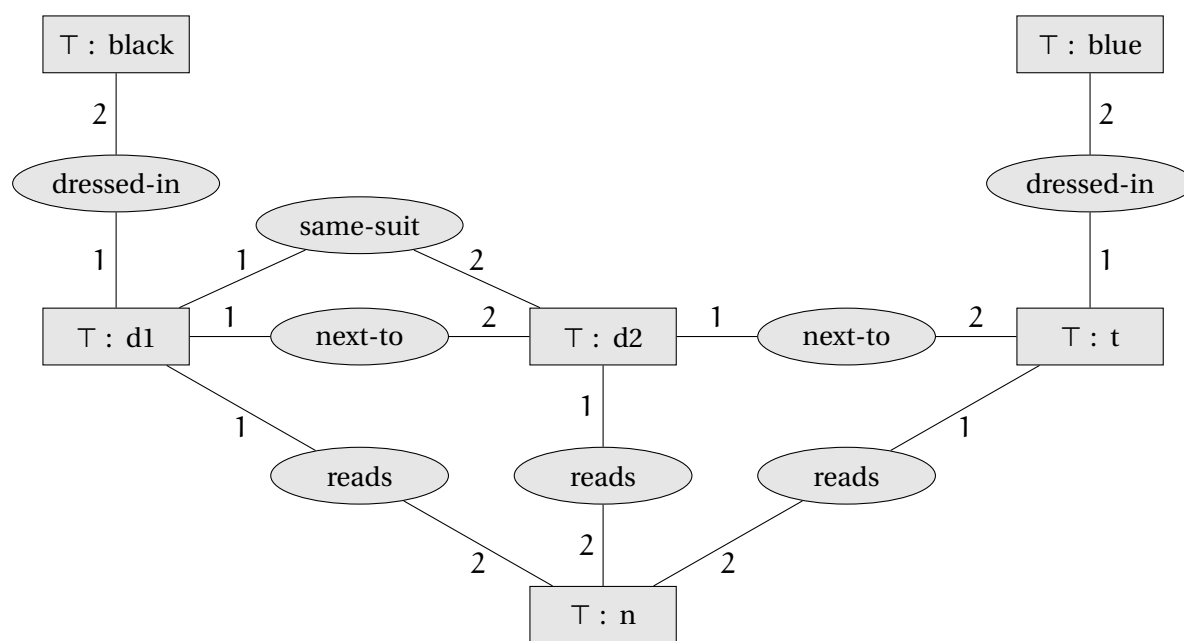

Figure 3.3: Conceptual graph corresponding to the fact in the example.

Rules have been introduced to conceptual graphs by [Chein et Mugnier, 2009]. A CG-rule is also split in head and body. Dotted lines link the concepts or individuals that are the same between the head and body of the rule.

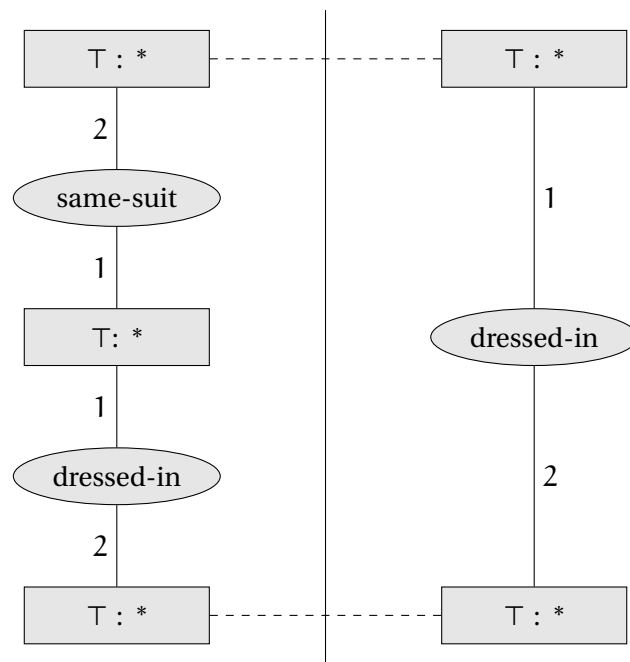

Figure 3.4: Conceptual graph rule corresponding to the rule in the example.

The CG-rule in Figure 3.4 represent the rule R , which is $= \{\{\text{same-suit}(X, Y), \text{dressed-in}(X, Z)\} \rightarrow \{\text{dressed-in}(Y, Z)\}\}$.

3.6.2 $F \models Q$ and $F, \mathcal{R} \models Q$

CoGITaNT is able to answer if a fact can be deduced from another one via a graph homomorphism algorithm. Indeed, a fact F entails a query Q iff there is an homomorphism from Q to F , and thus iff there is a graph homomorphism from the graph representing Q to the graph representing F . The conceptual graph representing the query from the example is represented in Figure 3.5.

The algorithm is bundled with a rule application mechanism. CoGITaNT implements a forward chaining process.

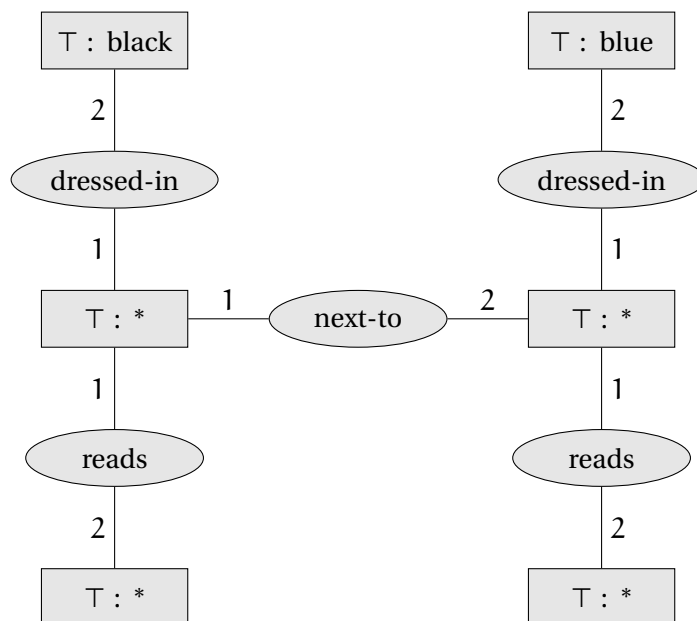

Figure 3.5: Conceptual graph corresponding to the query in the example.

As for Prolog, the CoGITaNT platform only stores graphs to be reasoned upon in main memory, thus making it unable to deal with large graphs. The idea of porting it in order to enable it to handle secondary memory stored graphs has been declined due to the emergence of new graph databases.

3.7 Graph databases

Most of the graph databases occurred in the context of the NoSQL movement share an idea that the flexibility of representation is somehow the most important feature a graph database should propose. As proof of concept thought, most of those graph databases import RDF. This does not mean they are not interested in the logic, but more that they let the user the choice of how to represent the data by giving them very simple tools.

Lately, most of the recent implementations of graph stores have agreed in using a common data model [Robinson *et al.*, 2013], which is called the Property Graph model.

Like any other data model, the Property Graph model does only concern the data and does not supply any guideline about stores technical issues or features. Most of the differences between those emerging stores rely on scalability, indexing and transaction features, that are implemented or not on such stores.

In this section, we describe more in detail the Property Graph model itself, instead of listing the description of the stores in the category. Such description takes place in the next chapter, along with their integration to the ALASKA platform. On the popular stores that do not use the Property Graph model as data model, it is worth citing HyperGraph DB, which data model relies on the use of hypergraphs (n-ary relations) instead of graphs allowing only binary relations. A store based on hypergraphs would better match a logical representation than a binary one, at least would fit it more naturally, as predicates in logic are not restricted to an arity of 2.

However, due to implementation choices, HyperGraph DB is not featured in the list of stores integrated to ALASKA due to its lack of a dynamic management of predicates. Indeed, all predicates and arities must be defined prior to the data insertion in the store. As discussed previously in Chapter 2 and also later in Chapter 5, such characteristic does not suit our need to perform multiple insertions of new pieces of information in an already instantiated knowledge base. For this reason, HyperGraph DB is not yet featured in the ALASKA platform.

3.7.1 Loading a knowledge base

Retrieving a knowledge base from a property graph model can be done as follows:

- Every node in the graph represents a term.
- Edges represent the relations between the terms. As all edges in the graph are binary, an edge represents a binary atom. The first term of the atom is the node corresponding to the source of the edge.

- Each node and edge possesses its own key-value table for storing raw information. Values in this table are of primary datatypes only.
- Nodes and edges do not have labels in the graph, but only an identifier. If there is no label specified in the key-value table, then the label of the term is its identifier.
- The same is valid if an edge does not have its predicate indicated in the key-value table of the edge. If no label is found, a new predicate is introduced.
- The information contained in the key-value table of a node, excepted its label, is represented via a new atom, in which the key is the predicate of the atom, the term being the first term of the atom and the value associated to the key the second.

Figure 3.6 shows a property graph that represents the fact F in the example.

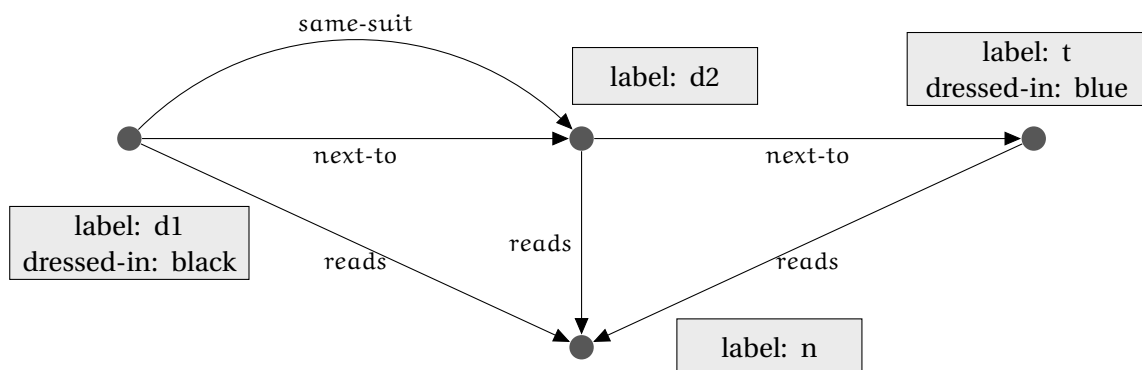

Figure 3.6: Property graph corresponding to the fact in the example.

As the Property Graph model only features binary edges, the knowledge bases extracted from property graphs will only feature binary predicates. Further in this work, we will write procedures for storing knowledge bases into graph databases. If the knowledge base given as input only features predicates of arity 2, then a straight-forward transformation is used. If not, it is needed to use a different graph representation, a bipartite one similar to conceptual graphs, where the two classes of nodes represent respectively concepts and relations. More details will be given in Chapter 5.

3.7.2 $F \models Q$ and $F, \mathcal{R} \models Q$

Conjunctive query answering over a graph database is performed through the graph homomorphism operation, as it is for CoGITaNT. Figure 3.7 shows a property graph corresponding to query Q in the example.

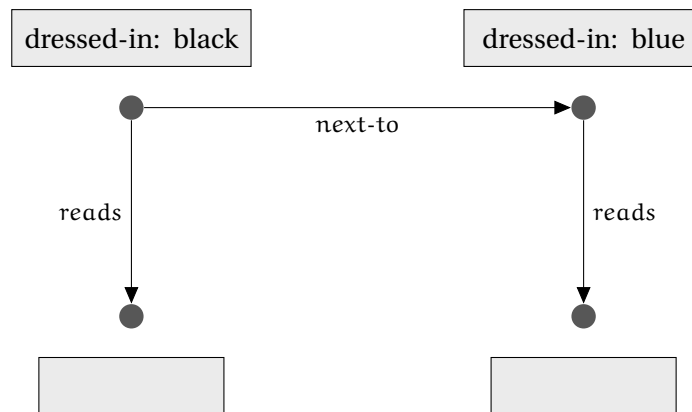

Figure 3.7: Property graph corresponding to the query in the example.

Some graph databases based on the property graph feature their own querying method/engine within their software, like Neo4J⁴ with the Cypher [Robinson *et al.*, 2013] language, which is able to perform conjunctive queries over a graph, and OrientDB⁵ that has adapted the SQL language to a graph-based data model instead of creating their own graph querying language. However, those querying interfaces or engines are not available through all the existing graph databases.

Rule application is also not natively featured on most graph databases implementations, which means that such feature is also to be developed on top of those stores when one wants to benefit from it.

4. <http://www.neo4j.org/>

5. <http://www.orientdb.org/>

3.8 Discussion

In this chapter, we have listed and evaluated the native capacities of different approaches for addressing the RBDA problem. The capacities evaluated were the ones of being able to load and maintain a knowledge base, to answer conjunctive queries upon the stored facts, and to answer conjunctive queries upon the stored facts potentially enriched by rules. By doing so, we will have a clearer view on which systems are worth considering and the ones that do not satisfy our needs. Figure 3.8 summarizes the capacities of each approach.

-	KB representation	$F \models Q$	$F, \mathcal{R} \models Q$	Sec. memory
Prolog	Yes	Native	Native	No
CoGITaNT	Yes	Native	Native	No
Relational Databases	Yes	Native (SQL)	Not native	Yes
Triple Stores	Yes	Native (SPARQL)	Not native	Yes
Graph Databases	Yes	Not native	Not native	Yes

Figure 3.8: Table comparing the features of the studied methods.

Prolog and CoGITaNT are the only systems previously described that integrate a native support of rules. Unfortunately, both systems require the load of the whole knowledge base in main memory prior to executing reasoning processes (a characteristic that we agreed to avoid once we focus on studying the efficiency of reasoning activity of systems/algorithms when dealing with very large amount of data). For those reasons, we will not consider both systems for the future.

On the other hand, relational databases are widely known for their ability of managing information stored in secondary memory. They also feature a native SQL interface which is able to perform conjunctive queries over the facts. Rules are not natively featured but can be introduced upon it. An interesting subject of study will be the efficiency of the SQL interface when performing queries over semi-structured data. As querying a relational

database is not restricted to SQL, we will also be able to write a custom algorithm for computing homomorphisms and verify its efficiency against the SQL interface. Those aspects will be covered and detailed later on in this thesis.

The case of triples stores is similar to the one of relational databases. Most implementations of those stores feature a native SPARQL interface in order to perform conjunctive queries. Comparisons between those and homomorphism computing will also be made. Graph databases however does not always feature a native querying interface and in those cases writing a querying algorithm is required in order to perform conjunctive queries over the data. Graph homomorphism algorithms have already been used before on data stored in main memory. The focus of this work will then be to check their efficiency when dealing with data stored on disk.

Based on these conclusions, we propose a new software platform that will first serve as a testing suite for all the systems that were not discarded after this first analysis. Our work will focus in transforming and translating information in order to have a common data language which is compatible to the formalism presented in Chapter 2 and shared by all the connected storage systems. To this end, we aim creating a multi-layered architecture featuring an abstract layer composed of classes and interfaces that would act as a physical representation of the positive subset of First Order Logic we work with. Such layer would ensure the equivalence between the operations on the data no matter which is the data model of the storage system that holds the information.

A single question can be more influential than a thousand statements.

B. BENNETT

4.1 Chapter Overview

In this chapter, we introduce ALASKA, a software architecture implemented for our research purposes. We start this chapter by explaining our motivation in creating a software architecture in 4.2. Section 4.3 details the foundations of ALASKA by describing each layer of the architecture, while Section 4.4 explains the genericity aspects of the backtracking algorithm featured in ALASKA. Section 4.5 presents the different storage methods used in ALASKA, giving an overview of the storage systems integrated to the platform. Section 4.6 illustrates, through an example, how ALASKA manages information represented by logical expressions in order to store them in the available storage systems, while Section 4.7 explains how such software architecture may be used for addressing the RBDA problem.

Finally, Section 4.8 provides a discussion about existing and possible future use cases for ALASKA.

The contribution of this chapter is ALASKA itself, the software architecture designed and implemented initially for addressing the RBDA problem, suitable for any knowledge representation application dealing with resources not located in primary memory only.

4.2 Introduction to ALASKA

As explained in Chapter 3, different approaches have led to different methods to implement software systems able to perform conjunctive query answering over a knowledge base. Such approaches being with, or without, the presence of an ontology to enrich such knowledge base. Although the description of the problem itself has remained the same, several new factors have altered its current nature and, consequently, the manner to proceed in order to address it. In the list of the main factors that have led to this situation, the emergence of very large and unstructured knowledge bases. Setting the threshold that defines what is a very large knowledge base may be a tricky task. We have defined by "very large" a knowledge base containing an amount of information that cannot be entirely stored in one single machine main memory at any part of the process. We tend to consider large knowledge bases containing information going from approximatively 10 million triples up to 1 billion triples (and more...). This list of factors also features the emergence of different database management systems using different data models than the traditional relational one (See the NoSQL movement in Chapter 3).

As previously mentioned, such factors have led the existing methods to fail, or at least to become obsolete due to inefficiency. Although the idea of having a working software suite to allow users to perform conjunctive queries over knowledge bases stored in secondary memory is not new, there is still no tool able to give a more in-depth analysis of the previous failures while, at the same time, integrate and test the latest algorithms and storage technologies. The lack of such a tool has led us to study how to proceed in

order to develop a tool that would enable a better study of the ODBA problem. The study has become the starting point of ALASKA [da Silva *et al.*, 2012], a project that would enable users to store pieces of information in predefined encodings directly into secondary memory, without having to perform any manual manipulations. ALASKA, an acronym for an "Abstract and Logic-based Architecture for Storage and Knowledge bases Analysis" would realize such task of translating information from one encoding to another in a totally transparent manner for the user, using First Order Logic as intermediary language. Once the information is stored, ALASKA would also work as a querying interface, allowing one to query the stored information using queries presented in different querying languages.

Although efficient storage and querying is the aim of the work that has resulted in the birth of ALASKA, it is also fundamental to state that its functionalities and features should not be limited to the study of ODBA. The ability of using logical representations internally and having an easy and simple connection to the stores on disk could directly enhance performances of other studies in the KR field. Some applications, such as rule application and record linkage studies [Newcombe *et al.*, 1959] will be presented more in detail in Section 4.8, but one thing to highlight is that any application requiring logical operations over large amounts of data may benefit from the features of ALASKA.

In order to adapt to the different types of applications aiming to manage or manipulate large amount of information, ALASKA will not only feature a range of options of storage methods an user can choose, but also a range of readers and parsers, able to transform different types of data as input into its internal logical representation before being stored on disk. By doing this, ALASKA can be considered a software enabling users and programmers to store and manage their information into different aspects without having to reach and manipulate the data itself.

The choice of using JAVA as language for the platform is based on several aspects. Even if the fact of being run inside a virtual machine (VM) makes code execution less efficient,

JAVA has become more and more popular and is today the best choice when one wants to easily integrate libraries and other pieces of code into another project (such as ALASKA does). Also, a lot of storage systems are currently written in JAVA, either come with a JAVA client API. In this trade-off where a *wide* investigation of existing storage systems (integrating many relevant systems) is opposed to a *in-depth* one (enhancing the efficiency of ALASKA in certain circumstances), we have favored the *wide* choice. This choice is also motivated by the priority of our research group to have a fully functional system able to compare and address heterogeneous sources, and not necessarily to create the fastest system for RBDA.

4.3 Foundations of ALASKA

The ALASKA core (data structures and functions) is written independently of any language used by storage systems it will access. The advantage of using a subset of First Order Logic to maintain this genericity is to be able to access and retrieve data stored in any system by the means of a logically **sound** common data structure. **Local encodings** will be transformed and translated into any other **representation language** at any time. The operations that have to be implemented are the following: (1) retrieve all the terms of a fact, (2) retrieve all the atoms of a fact, (3) add a new atom to a fact, (4) verify if a given atom is already present in the facts.

Basically, the abstract layer of ALASKA is a logical layer. Storage systems are used to store data that can be seen as sets of logical atoms of form $p(t_1, \dots, t_k)$. Wrappers are used to encode this atom according to the storage system paradigm. For instance, this atom will be encoded as the line (t_1, \dots, t_k) in the table p in a relational database, and as a directed hyperedge labeled p whose incident nodes are the ones encoding respectively t_1, \dots, t_k in a graph-based storage system.

Whatever this storage system, ALASKA only reads and writes atoms or sets of atoms. It

is thus entirely possible, for instance, to read the RDF triples (s, p, o) stored in Jena (they will be seen as atoms $\text{pred}(s, p, o)$), and write them in a SQL database, where they will be stored as lines (s, o) in the table p .

This abstract layer is not only used to read and write in an uniform manner into various storage systems, but also to process queries. A conjunctive query can also be seen a set of atoms. ALASKA is able to transform them into, for example, SQL or SPARQL queries, to benefit from the native querying mechanism of specific storage systems. Moreover, a generic backtracking algorithm has been designed, that allows to process these queries on any of these storage systems. This backtrack relies upon elementary queries, that check whether or not a grounded atom is stored in the system, or enumerate all atoms that specialize a given one. This backtrack does not incorporate powerful optimizations and pruning features, since it is designed to process simple queries. For more difficult queries, a constraint solver, based upon Choco [Jussien *et al.*, 2008], relies upon the same elementary queries (this constraint solver is currently under evaluation).

Though ALASKA is designed as a generic platform for RBDA (Rule-Based Data Access), it does not yet integrate any ontological reasoning features. We have designed this platform to be fully compatible with existential rules (also known as Datalog+/-) [Calì *et al.*, 2009]. These rules are powerful enough to encode the semantics of RDF(S), or "lite" description logics families such as DL-Lite or \mathcal{EL} families. There is an ongoing work aiming to integrate such families in ALASKA. More details about this project will be given in Section 4.8.

The platform architecture is multi-layered. Figure 4.1 represents its class diagram, highlighting the different layers.

The first layer is (1) the **application** layer. Programs in this layer use data structures and call methods defined in the (2) **abstract** layer. Under the abstract layer, the (3) **translation**

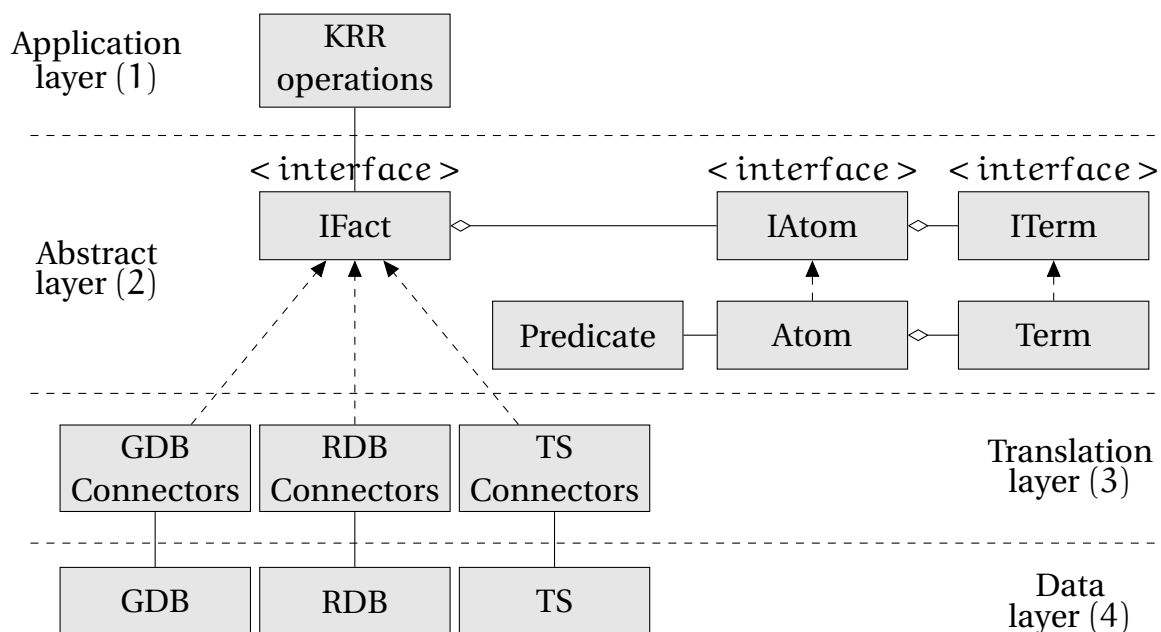

Figure 4.1: Class diagram representing the software architecture.

layer contains pieces of code in which logical expressions are translated into the languages of several storage systems. Those systems, when connected to the rest of the architecture, compose the (4) **data** layer. Performing higher level KRR operations within this architecture consists of writing programs and functions that use exclusively the formalism defined in the abstract layer. Once this is done, every program becomes compatible to any storage system connected to architecture.

4.4 Querying Algorithms

4.4.1 Backtracking algorithm

Before performing any querying activity, we also need to define the purpose of using ALASKA as a querying interface instead of using any native solution. We have agreed that ALASKA would help us to define which are the most efficient solution for querying a large knowledge base, by comparing systems and querying engines when answering conjunc-

tive queries. Two different factors come into play when performing the queries: memory consumption and execution time. In the test we will present, we are only considering execution time to define efficiency. We acknowledge the fact that memory consumption is certainly important, especially when performing complex queries over very large bases stored in secondary memory, but we do not consider this aspect in our tests. Please note that this is configurable and possible to control within ALASKA. The reason is twofold. First handling memory consumption for each system (and optimizing it) is not part of our comparing tests (or of the generic functionality offered by ALASKA). Second, intuitively, comparing a generic algorithm over different storage systems (and thus calling the elementary operations of each) should not lead to important differences between the systems at hand.

The generic backtrack algorithm used in ALASKA takes a query and for each term explores the candidate answers in the KB. The backtrack is due to the fact that the terms have to be correctly included in the right atoms (i.e. by the right predicates). The algorithm relies on the state of the "level" and "goingUp" variables in order to proceed to the exploration of the knowledge base. The algorithm starts by ordering the terms of the query. The algorithm does not require any particular order to work properly, but ordering strategies can enhance the efficiency of the algorithm. In the tests performed, our ordering was very simple: it consisted in sorting the terms list by letting the constant terms ahead of the variable terms. Inside the constant and variable parts of the list, the terms are ordered as they appear in the query. More elaborate orderings can be implemented as it relies on a custom function for ordering terms. level corresponds to the index of the term the algorithm is trying to match, while goingUp indicates if the algorithm continues its exploration, has reached a dead end or has found a match for all the terms. In the later case, a successful answer to the query has been found.

Algorithm 2: Backtrack algorithm

Input: A conjunctive query Q , and a fact F **Output:** lists all the answers of Q in F

```

1 begin
2    $Q \leftarrow \text{order}(Q)$ ;
3    $\text{level} \leftarrow 0$ ;
4    $\text{goingUp} \leftarrow \text{false}$ ;
5   if  $H = \emptyset$  then
6      $\text{answerFound}(Q)$ ;
7   else
8     while  $\text{level} \neq 0$  do
9       if  $\text{level} = |Q|$  then
10         $\text{answerFound}(Q)$ ;
11         $\text{goingUp} \leftarrow \text{true}$ ;
12        else  $\text{currentTerm} = Q[\text{level}]$ ;
13        if  $\text{goingUp}$  then
14          if  $\text{otherCandidates}(\text{currentTerm}, F)$  then
15             $\text{goingUp} \leftarrow \text{false}$ ;
16             $\text{level} \leftarrow \text{level} + 1$ ;
17          else  $\text{level} \leftarrow \text{level} - 1$ ;
18        else
19          if  $\text{findCandidates}(\text{currentTerm}, F)$  then
20             $\text{level} \leftarrow \text{level} + 1$ ;
21          else
22             $\text{goingUp} = \text{true}$ ;
23             $\text{level} \leftarrow \text{level} - 1$ ;
24 end

```

4.4.2 Abstract Procedures

As the mechanism of the algorithm is quite simple, its efficiency is then very tightly linked to the efficiency of the sub-functions `findCandidates` and `otherCandidates`. `findCandidates` is called once the algorithm goes a level below and has to search all the terms in the knowledge base that can be a match for a given term of the query. The second one is called every time the algorithm goes back up to a level previously visited, modifying

the current matching of a term to a different candidate, and going back down to search for new answers. If there are not any new candidates for such term of the query, the function then returns false, and the algorithm goes back up again. The algorithm stops once there are no candidates left for the first term of the query, which means that there is nothing left to explore.

Considering that the `otherCandidates` function only modifies a value of the matchings set currently built, and that all the matching candidates for a given term are previously computed using the `findCandidates` function, the `otherCandidates` function has a very small impact to the time and memory usage of the algorithm. Technically, it only consists of moving forward an iterator, thus the efficiency of the algorithm relies mainly on the efficiency of the `findCandidates` function. We will explain in the following how this function can be quite costly in certain cases.

Indeed the number of calls to its sub-functions (`enumerate` and `check`) depends on the number of times a term appears in the query. `enumerate` and `check` may be considered as the elementary operations of the backtrack algorithm. When called, `enumerate` returns a list containing all the terms in the knowledge base that has exactly for neighbours the matchings of the neighbours of a given term of the query. While the `check` function asks the system managing the knowledge base whether a given atom can be found in the base or not. The number of calls to the `check` function depends directly on the quantity of results returned by the calls to the `enumerate` function. As the `enumerate` function computes the potential candidates for a match, the `check` function verifies if a given candidate has to be maintained or discarded as a candidate. The number of calls to both functions generally increases as the size of the knowledge base also grows.

It is very important to state that during the execution of the backtracking algorithm the entire communication between the algorithm and the storage system in which the knowledge base is stored is performed through the `enumerate` and `check` function calls. No external communication between them is allowed, and that is what maintains the

complete genericity of the algorithm. It is then mandatory to implement both functions in every system one wants to integrate to ALASKA. Querying the knowledge base with the generic algorithm is impossible if such implementation is not performed. Those are however not the only functions required for every storage system integrated to the platform. The `enumerate` and `check` functions require knowing from a knowledge base whether a term exists in the base or not, whether a predicate exists in the base or not, and whether two given terms belong to an atom with a given predicate or not. These are what we call the consulting, or reading functions required by ALASKA. Along with the writing functions needed to store a knowledge base, these functions compose the core functions that ALASKA needs to manage a knowledge base stored in a given storage system. More details about those functions are given in Chapter 5.

For each query, according to its structure and the degree of the terms of the query, the number of calls to `enumerate` and `check` will differ. As the efficiency of the algorithm relies on the efficiency of those two functions, we have added intermediary timers in order to enable ALASKA to measure the time the algorithm spends in each of those calls. This way, one performing a query is not only allowed to retrieve the total time of the execution of a query, but also how much of that time was spent enumerating candidates or retrieving atoms in the knowledge base.

4.5 Storage systems

By having several different stores connected to ALASKA, one of our main contributions of the software is to help make explicit different storage system choices for the knowledge engineer in charge of manipulating the data. More precisely, ALASKA can encode a knowledge base expressed in the positive existential subset of first order logic in different data structures (graphs, relational databases, 3Stores etc.). This allows for the transparent performance comparison of different storage systems.

The performance comparison is done according to the (1) storage time relative to the size of knowledge bases and (2) query time to a representative set of queries. On a generic level the storage time need is due to forward chaining rule mechanism when fast insertion of new atoms generated is needed. We also needed to interact with a server of ABES, the French Higher Education Bibliographic Agency, for retrieving their RDF(S) data. We explain this more in detail in Section 4.8. The server answer set is limited to a given size. When retrieving extra information we needed to know how fast we could insert incoming data into the storage system. Second, the query time is also important. The chosen queries used for this study are due to their expressiveness and structure. Please note that this does not affect the fact that we are in a semi-structured data scenario. Indeed, the nature of ABES bibliographical data with many information missing is fully semi-structured. The generic querying allowing for comparison is done across storage using a generic backtrack algorithm to implement the backtracking algorithm for subsumption. ALASKA also allows for direct querying using native data structure engines (SQL, SPARQL).

In this work, we have given the priority to the integration of embeddable storage systems within ALASKA. By embeddable, we mean that the storage system core is packed and is distributed inside the main application using the store. This kind of system is opposed to the stores featuring the client-server architecture, where the client connects to the server through a port and asks for the server to perform the operations it wants, while the server takes care of the physical management of the data requested. Client-server stores is the most appropriated choice when one is interested in deploying the content of the database to several clients or throughout a network. Very often, an embeddable system is a simple solution for an application in need of simple and direct access (non-secured very often) to the data. In this case, the system features an API with the functions needed to manage the data directly without calling a third-party server.

In some cases it may happen that a store is deployed as a client-server architecture, but both client and server are located on the same host. In this case, no network com-

munication is needed. Such solution may bring an efficiency loss when interacting with the storage system. That is the case for instance when one executes multiple operations that can not be regrouped over a database via a JDBC driver. The communication with the driver, then with the server before having access to the information is responsible for slowdowns when executing the program.

Next section will feature short descriptions of the current embeddable stores that were connected to ALASKA and were also used for the experimental aspects of this thesis, featured in Chapter 5. This list is not final. Others systems were also connected and tested but are not part of the work in this thesis. Also, there are also other stores in which the writing of a connector is needed in order to use it within ALASKA. The stores featured in this work are the following:

- **Relational databases:** Sqlite
- **Graph databases:** Neo4J, DEX
- **Triples stores:** Jena TDB

4.5.1 Relational databases



Sqlite SQLite¹ is the embedded relational database used within ALASKA. It is a very lightweight relational database management system written in C. SQLite is ACID-compliant, which means that it supports transactions natively. and implements most of the SQL standard. The fact that it is an embedded store has made SQLite be very popular in the world of mobile and desktop applications. Plenty of different programs

1. <http://www.sqlite.org/>

embed SQLite and use it for internal storage of data and options (cf. Mozilla Firefox). This way, it differs itself from the "larger" relational database management systems, which are deployed on servers and are very widely known for their use on business and industrial applications (MySQL, Oracle, etc.). It was possible to connect SQLite to ALASKA thanks to the existence of a JDBC driver for SQLite. Such driver was not provided by the SQLite developers themselves but by a third-party project.

4.5.2 Graph databases

The following graph databases have been used within ALASKA:



Neo4J Neo4J² is a graph database, and is by far the most popular graph database at the moment, at least in the industrial world. Started as a small project, Neo4J has seen its popularity being multiplied by a huge factor in the recent years. It is now distributed under two distinct versions: Neo Technologies offers now a commercial version of the database along with support, while the former open source version of the database is still available via a "Community" version still maintained by the core developers of Neo and using the help of a large community of developers that have embraced the Neo4j project. It is fully implemented in JAVA. It is an embedded store but it is absolutely possible to deploy the store on a server dedicated to store data and handle queries from distinct users. The internal structure of Neo4j is based on the Property Graph model. It is also ACID-compliant, which means that it ensures the properties defined by Codd for relational databases (Atomicity Consistency Isolation Durability), that ensures the reliability of data transactions. For that, it features a fully transactional persistence engine that secure transactions and data manipulation throughout time.

2. <http://www.neo4j.org/>



DEX DEX³ is a graph database management system written in Java and C++. It was originated by the research carried out at the DAMA-UPC research group in Barcelona. Since 2010 is maintained, upgraded and distributed by Sparsity Technologies. DEX is licensed under a proprietary license of Sparsity Technologies, but is free for academic use. It is another graph database that has been seeing a strong success both in academia and business world. DEX internal model of a graph is fully compatible with the Property Graph. The internal representation of a graph in DEX is very particular, as the graph is often partitioned according to the graph structure, and also because of the fact that information such as nodes and edges identifiers are regrouped and encoded into large bitmaps. The major strength of DEX is the ability of having very fast reading and writing operators at lower level able to manipulate those large bitmaps with great efficiency. At higher level, the system features all the operations needed in order to enable the user to manage a graph stored by DEX as any Property Graph. Unlike Neo4J, DEX is not ACID-compliant.

4.5.3 Triples stores

The following triples stores have been used within ALASKA:



Jena Jena⁴ is a Semantic Web framework for Java. It provides an API to read data from RDF content, to manage it, query it and then to write such content in different formats. The project also provides an internal embedded Triple Store, which is called TDB. This is the part of the framework we will be connecting to ALASKA and thus comparing it to the

3. <http://www.sparsity-technologies.com/dex>

4. <http://jena.sourceforge.net/>

other kind of stores already connected to the platform. Other features of the framework such as parsing and output will not be used in ALASKA for now. This is due to one of the major drawbacks of the Jena framework which is that it keeps an internal representation of the workbench as an abstract model in main memory. Which means for instance that parsing a very large knowledge base located on disk could make the machine where the parser is located to run out of memory very fast. More details on those issues will be related on Chapter 5. Jena is an Open Source project, started by HP and now maintained by the Apache Foundation.

4.6 Example

The translations detailed above will now be explained through the means of an example. In this example, we will use a knowledge base represented by an image. Such knowledge base contains a fact and no ontology. The fact corresponds to the information contained in the image. This information will first be extracted (manually) from the image and represented as a text. From the text, a knowledge base will be created, and the information of the text will then be transformed into logics. Once the logical expression of the fact is obtained, it will be then transformed in order to be stored in any of the storage methods supported by ALASKA.

For this example, we will use once again Figure 3.1 presented in 3. The information we have extracted from the image this time is the following:

The picture features three men. Two of them are twins. Both of them are wearing a suit. Both suits are black. One of the twins is holding and reading a newspaper. The other man is also reading the newspaper. He wears a blue shirt.

From this paragraph, we will manually create the knowledge bases for the example. Two different knowledge bases, K_1 and K_2 will be created: one featuring only predicates of

arity 2, and the other one without any restriction in the arities of predicates.

For K_1 , the predicates of the example are: *type*, *twins*, *wears*, *reads*, *holds*, *color*, all of arity 2. The variables of the example are m_1 , m_2 and m_3 for the three men, s_1 and s_2 to represent the suits, and s_3 for the shirt. n will represent the newspaper. Colors and object types are represented as constants: *Black*, *Blue*, *Man*, *Suit*, *Shirt*, *Newspaper*.

For K_2 , the predicates (with their arities) of the example are: *man* (1), *suit* (1), *shirt* (1), *newspaper* (1), *twins* (2), *wears* (2), *reads* (2), *holds* (2), *color* (2). The variables of the example are: m_1 , m_2 and m_3 for the three men. s_1 and s_2 represent the suits, s_3 the shirt and n will represent the newspaper. Now, only the colors are represented by constants, *Black* and *Blue*.

Figure 4.2 summarizes the vocabularies of both knowledge bases:

K ₁			K ₂		
Predicates (6)	Variables (6)	Constants (5)	Predicates (11)	Variables (7)	Constants (2)
<i>type</i>	m_1	<i>Black</i>	<i>man</i> (1)	m_1	<i>Black</i>
<i>color</i>	m_2	<i>Blue</i>	<i>suit</i> (1)	m_2	<i>Blue</i>
<i>twins</i>	m_3	<i>Man</i>	<i>hat</i> (1)	m_3	
<i>wears</i>	s_1	<i>Suit</i>	<i>shirt</i> (1)	s_1	
<i>reads</i>	s_2	<i>Newspaper</i>	<i>newspaper</i> (1)	s_2	
<i>holds</i>	s_3		<i>same-as</i> (2)	s_3	
	n		<i>twins</i> (2)	n	
			<i>wears</i> (2)		
			<i>reads</i> (2)		
			<i>holds</i> (2)		
			<i>color</i> (2)		

Figure 4.2: Listing of the K_1 and K_2 vocabularies.

The logical expression of the fact in K_1 is:

$$\exists m_1, m_2, m_3, s_1, s_2, s_3, n \ (\text{type}(s_1, \text{Suit}) \wedge \text{type}(s_2, \text{Suit}) \wedge \text{type}(s_3, \text{Shirt}) \\ \wedge \text{type}(h_1, \text{Hat}) \wedge \text{type}(h_2, \text{Hat}) \wedge \text{type}(m_1, \text{Man}) \wedge \text{type}(m_2, \text{Man}) \wedge \\ \text{type}(m_3, \text{Man}) \wedge \text{type}(n, \text{Newspaper}) \wedge \text{twins}(m_1, m_2) \wedge \text{wears}(m_1, s_1) \wedge$$

$$\text{wears}(m1, h1) \wedge \text{wears}(m2, s2) \wedge \text{wears}(m2, h2) \wedge \text{wears}(m3, s3) \wedge \text{reads}(m2, n) \wedge$$

$$\text{reads}(m3, n) \wedge \text{holds}(m2, n) \wedge \text{color}(s1, \text{Black}) \wedge \text{color}(s2, \text{Black}) \wedge \text{color}(s3, \text{Blue})$$

While the logical expression of the fact in K_2 is:

$$\exists m1, m2, m3, s1, s2, s3, n (\text{man}(m1) \wedge \text{man}(m2) \wedge \text{man}(m3) \wedge \text{suit}(s1) \wedge$$

$$\text{suit}(s2) \wedge \text{shirt}(s3) \wedge \text{newspaper}(n) \wedge \text{twins}(m1, m2) \wedge \text{wears}(m1, s1) \wedge$$

$$\text{wears}(m1, h1) \wedge \text{wears}(m2, s2) \wedge \text{wears}(m2, h2) \wedge \text{wears}(m3, s3) \wedge \text{reads}(m2, n) \wedge$$

$$\text{reads}(m3, n) \wedge \text{holds}(m2, n) \wedge \text{color}(s1, \text{Black}) \wedge \text{color}(s2, \text{Black}) \wedge \text{color}(s3, \text{Blue})$$

ALASKA is now able to store such information in any storage system connected. The transformations used within ALASKA are explained in Section 5.2. In the case of a relational database, different schemas are possible as the user has to choose if he wants to have one table per predicate, or one single table (when it is possible), and also how to keep track of which terms are variables or not. In this example, the atoms of K_1 will all be stored in one single table, as K_1 only features predicates of arity 2, and the terms will be renamed according to the fact that they are constants or variables. K_2 will be stored in a database with one table per predicate, with an extra table containing the list of variables in the knowledge base. One should not forget that the schema definition and the tuples insertion is still independent of the chosen RDBMS.

Figures 4.3 and 4.4 show how K_1 and K_2 will be stored in a relational database. The storage process is detailed in Section 5.2.

In the case of graph databases, the transformation is not unique and straight-forward as it is for relational databases, it depends on the data model of the chosen store. As seen previously, in this work we will only focus on the graph databases using the Property Graph model. For K_1 , which has only predicates of arity 2, the transformation is straight-forward by representing the terms of the knowledge base by nodes and the atoms of the logical

triples		
col _p	col ₁	col ₂
type	v:s1	c:Suit
type	v:s2	c:Suit
type	v:s3	c:Shirt
type	v:m1	c:Man
type	v:m2	c:Man
type	v:m3	c:Man
type	v:n	c:Newspaper
twins	v:m1	v:m2
wears	v:m1	v:s1
wears	v:m2	v:s2
wears	v:m3	v:s3
reads	v:m2	v:n
reads	v:m3	v:n
holds	v:m2	v:n
color	v:s1	c:Black
color	v:s2	c:Black
color	v:s3	c:Blue

Figure 4.3: Storing K_1 in the relational database.

formula by edges between the nodes of the terms of each atom. K_2 will need, however, a different transformation as it contains predicates with an arity different than 2. In this case, ALASKA will use the transformation that represent the atoms predicates by nodes, connecting each term node to its predicate node and precising the position of such term in the atom.

Figures 4.5 and 4.6 illustrate K_1 and K_2 properly encoded in the Property Graph model, using the two distinct transformations, ready for storage in a graph database.

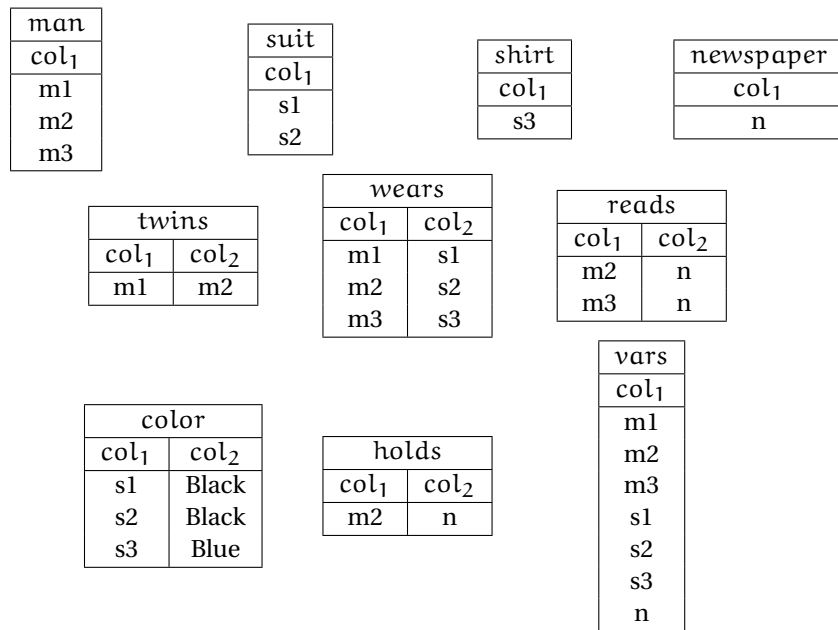

Figure 4.4: Storing K_2 in the relational database.

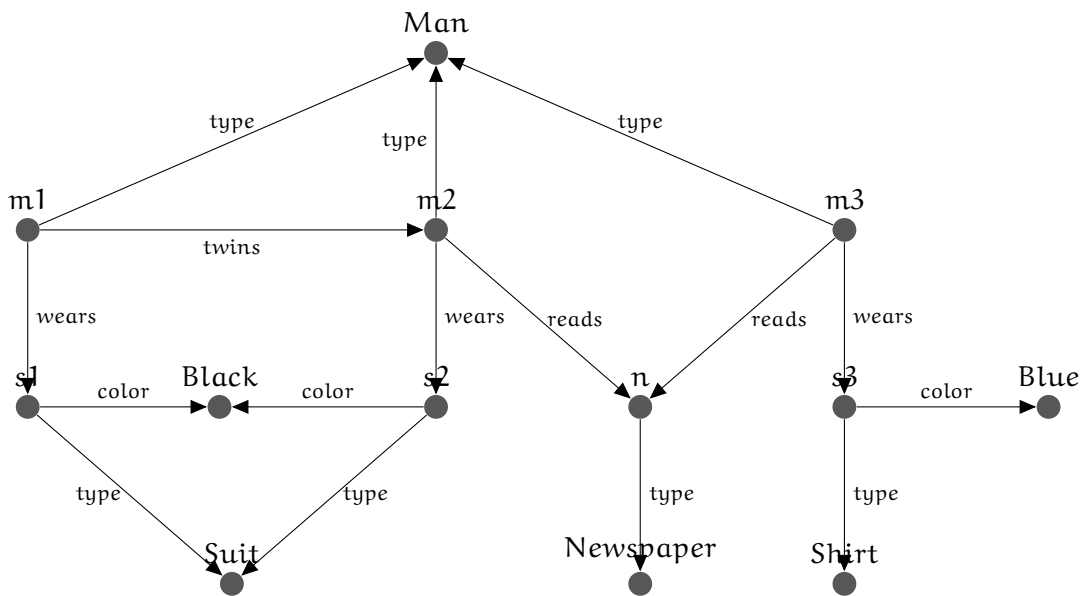

Figure 4.5: Storing K_1 in a graph database using the Property Graph Model.

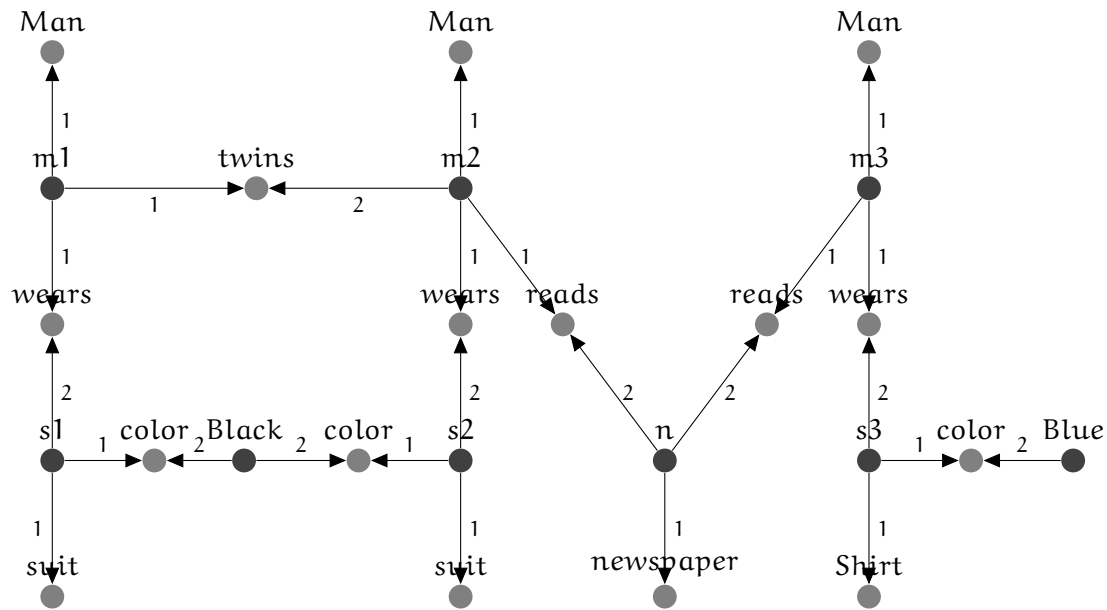

Figure 4.6: Storing K_2 in a graph database using the Property Graph Model.

4.7 ALASKA for RBDA

Previously in Chapter 2, we have explicated two distinct methods in order to perform rule application to a knowledge base: forward and backwards chaining. In a forward chaining process, several homomorphisms are computed in order to find which rules have a body that can be projected to the facts and thus be applied. The applied rules generate new pieces of information that are added to the facts, and new homomorphisms computations are then made to find which rules can be applied to the enriched facts, until facts are saturated. In a backwards chaining process, besides the need of a query rewriting engine, it is also needed to compute a large amount of homomorphisms once the queries are rewritten. This means that independently of the rule application method chosen, a system able to perform a large amount of homomorphisms efficiently is highly needed. Furthermore, we also need a system that is able to insert small pieces of information in a knowledge base that can already be very large in an efficient manner. No forward chaining

algorithm could work properly without such a feature.

During this work, we will not design nor implement rule application algorithms or query rewriting engines (see Section 4.8). We will however focus on the insertion and querying operations over knowledge bases. Both situations may be defined as elementary operations of RBDA. After having listed existing systems worth to check in Chapter 3, the work in Chapter 5 will be to design testing protocols in order to verify the efficiency of those systems in real use cases for those key situations. Studying the efficiency of such systems might lead us to see how they adapt to our need of finding a system that would perform both operations efficiently. Other objectives and future use cases of ALASKA will be discussed in the next section.

4.8 Use cases for ALASKA

The use of ALASKA platform is evidently not limited to the analysis of the efficiency of different storage systems according to the elementary operations of RBDA. The abstraction and genericity it has been granted at design phase allow the platform to be used in any other application that would need to benefit from a logic based model or simply from the connection to different storage systems at lower level. We believe that ALASKA may become an useful element in any knowledge representation application in the future, as it would only need the integration of new parsers and database connectors.

However, before thinking that far with the reutilisation possibilities of the ALASKA platform in other environments, the first goal (or use case) for ALASKA is to be RBDA-ready, which means to be able to perform conjunctive queries over a large and semi-structured knowledge base with the possibility of having the facts from the knowledge base enriched by rules. To this end, it is needed to implement and integrate rule application algorithms and/or query rewriting engines to the platform, which was not covered by this thesis. Such work requires an in-depth study of several classes of rules and the implementation

of algorithms for the decidable cases identified. This topic has been the subject of study for a quite large amount of time, and the implementation of rule application engines and their integration within ALASKA has been initiated with the thesis projects of M. Thomazo [Thomazo, 2013] and M. König [König *et al.*, 2013].

We will also motivate and explain the contribution of ALASKA by the means of a real world case from the ANR funded project Qualinca. Qualinca is aiming at the validation and manipulation of bibliographic / multimedia knowledge bases. Amongst the partners, the ABES (French Higher Education Bibliographic Agency) and INA (French National Broadcasting Institute) provide large sets of RDF(S) data containing referencing errors. Examples of referencing errors include oeuvres (books, videos, articles etc.) mistakenly associated with the wrong author, or authors associated with a wrong / incomplete subset of their oeuvres. In order to solve such referential errors Qualinca proposed a logic based approach (as opposed to the large existing body of work mostly employing numerical measures) [Croitoru *et al.*, 2012]. In this approach, author data is extracted from the loaded RDF(S) and stored as a graph. As the amount of data can be very large, this graph is created at runtime and may require external storage due to its unknown size. No existing tool in the literature can influence the knowledge engineer when it comes to helping him to decide which system is the best for this particular use case. ALASKA was then used in the project in order to create and manage the information in the graph obtained from the RDF(S) data extraction, with the possibility of storing that information in different available manners.

To conclude with the possible use cases of ALASKA, one should not forget that one of the main goals of the project is to have a software architecture that enables the development of several programs related to knowledge representation and information management in any kind. Although the core of the architecture is a purely logical representation of the information treated, the generic aspect of the platform, added to the large quantity of input/output connectors highly extends the capacities of integrating ALASKA in several

applications. One of those first use cases that comes in mind is the management and interrogation of information provided by heterogeneous data sources.

Experimental Work

Increasingly, the central question is becoming who will have access to the information these machines must have in storage to guarantee that the right decisions are made.

J-F. LYOTARD

5.1 Chapter Overview

In this chapter, we summarize all the experimental work performed during this thesis around the ALASKA platform. The chapter begins detailing the algorithms in ALASKA for storing a knowledge base into different storage systems in Section 5.2. Section 5.3 isolates some functions of the abstract layer of ALASKA and explains their implementation in different systems. Section 5.4 details the data used to the experimental protocols of this thesis. Finally, Sections 5.5 and 5.6 close the chapter by presenting the testing workflows,

results and discussions around the storage and querying efficiency tests using ALASKA.

We will first explain the genericity aspects of ALASKA by giving an in-depth look to the connections between the platform and the storage systems. We will then present the testing protocols designed for investigating the efficiency of those systems according to their storage and querying capacities. The contributions of this chapter are the following. We were able to evaluate storage mechanisms w.r.t our requirements (no a priori knowledge of data, no a priori indexation), to evaluate different algorithms for querying, and of the elementary querying mechanisms thanks to the generic backtracking algorithm, and to design a constraint-based programming algorithm for difficult instances.

5.2 Knowledge base storage

In this section, we explain how a knowledge base is stored in each of the storage systems connected to ALASKA.

5.2.1 Relational databases

Storing facts in a relational database needs to be performed in two distinct steps. First, the relational database schema has to be defined according to the vocabulary of the knowledge base. The information concerning the individuals in the knowledge base can only be inserted once this is done. According to the arities of the predicates given in the vocabulary, there are two distinct manners to build the schema of the relational database: In the classic case, one relation is created for each predicate in the vocabulary. The second case occurs only when all the predicates in the vocabulary share the same arity (cf. RDF [Hayes, 2004]). In this case, it is possible to define one single relation and to include the whole knowledge content in this relation. Such encoding is very similar to the ones used for Triples Stores [Hertel *et al.*, 2009].

One should not forget that there are no variables in a relational database. Indeed, variables are frozen into fresh constants before being inserted into a table. In order not to lose such information upon storing a fact, two alternatives exist: in the first method, a prefix is added to the label of every term of the database. A term t would then be renamed to $c:t$ if it is a constant or $v:t$ if it is a variable. In the second case, no changes are made to the label of the terms, but an extra unary relation, R_{vars} is created. Tuples containing the label of the variables in the database would then be added to the relation. Both alternatives have advantages and drawbacks: the first one does not alter the schema of the database in any case, but does rename every single term in it. On the other hand the second one does not rename any term of the database but does add a relation to the database schema. By adding a new table containing the variables information, a SELECT call is then needed to answer whether a term is a constant or variable in the second case, while it can be directly answered by reading the term's label if the first method is used. For that reason, the first method will be preferred to the second one for our experimental processes. However, both solutions are available in ALASKA and the platform does leave the choice of use to the user, according to what he seems more appropriate.

Four different manners for storing a knowledge base in a relational database are possible, combining the two different options to keep track of the variables and the two different options according to the number of tables in the database. Below, we will present the algorithms of two of those four manners, in a way that every technical option is covered.

Algorithms 3, 4 are used when storing a fact in a relational database. In the first algorithm, one table is created in the database for each predicate in the knowledge base, while the second one is only for cases when all the predicates share the same arity. Also, in the first algorithm, an extra table named `vars` with a single column is created at the beginning in order to store variables. That does not happen in the second, as the system keeps track of the variables by renaming the terms inside the tables before insertion.

Algorithm 3: KB to Relational Database algorithm

Input: K a knowledge base

Output: a boolean value

```

1 begin
2   create table vars (col1);
3   foreach Atom a in A do
4     p ← a.predicate;
5     if !exists table with label p then
6       n ← p.arity;
7       create table p (col1,...,coln);
8     foreach Term t in a.terms do
9       if t is a variable then insert into vars (t);
10    insert into p (t1,...,tn);
11  return true;
12 end

```

Algorithm 4: KB to Relational Database algorithm (v2)

Input: K a knowledge base, n the arity of all predicates of K

Output: a boolean value

```

1 begin
2   create table tuples (colp,col1,...,coln); foreach Atom a in A do
3     foreach Term t in a.terms do
4       if t is a variable then t ← v:t;
5       else t ← c:t;
6     insert into tuples (a.predicate,t1,...,tn);
7   return true;
8 end

```

The relational database management system used within ALASKA is SQLite. Versions 3.0 or higher of the RDBMS use a separate B+tree per table and a B-tree per index in the database. One can see that the algorithms defined above does not define any particular index and also does not define any primary or foreign keys. Indeed, the behaviour of ALASKA is not to make any supposition about the data that it is given for storage/management. Based on this idea, indexing the knowledge base in order to ensure a better efficiency upon reading stage would require to index all the tables by all its attributes, which would have a significant additional cost in space. As for tables, the fact that they do not have a primary key suggests that the information is stored in the B+tree using the rowid, an identifier for each row of a table kept by the system. A B+tree is a variant of the B-tree in which the sequential access has been improved by the use of pointers between leaves nodes of the tree.

5.2.2 Graph databases

Storing a knowledge base into a Property Graph-based database can also be done in two different manners, and as for relational database, the two manners differ according to the arities of the predicates in the knowledge base. In the first case, when all the predicates in the knowledge base are of arity 2, the transformation is straight-forward, with a node for each term, and an edge for each atom, connecting the nodes corresponding to the terms position in the atom. In the second case, it is needed to encode the bipartite graph with different nodes for terms and predicates (as seen in Conceptual Graphs in Section 3.6) corresponding to the knowledge base fact. The bipartite graph, being only composed of binary relations, is then easily stored to the database.

In both cases, we have chosen to have limited use of the key-value tables associated to the terms and edges of the graph. For terms, the term label and the information of whether it is a variable or not is stored in the table. In the case of edges, the label is the only information stored in the table.

Algorithm 5: KB to Property Graph algorithm

Input: K a knowledge base**Output:** a boolean value

```

1 begin
2   g ← empty graph;
3   foreach Atom a in A do
4     if exists node with label a.terms[0].label then
5       head ← node.id;
6     else
7       create new node with id newId;
8       newId.put(label,a.terms[0].label);
9       newId.put(variable,a.terms[0].isVariable);
10      head ← newId;
11     if exists node with label a.terms[1].label then
12       tail ← node.id;
13     else
14       create new node with id newId;
15       newId.put(label,a.terms[1].label);
16       newId.put(variable,a.terms[1].isVariable);
17       tail ← newId;
18     create new edge with id edgeId from head to tail;
19     edgeId.put(label,a.predicate);
20   return true;
21 end

```

Algorithm 5 displays the algorithm for storing a fact in a graph database for the first case, when all the predicates are binary. Algorithm 6 displays the version for storing any knowledge base into a property graph-based database.

In the first one, the graph creation process is very simple. For each atom of the fact, the algorithm creates an edge from the node corresponding to the first term of the atom to the node corresponding to the second one. The algorithm verifies first if both nodes already exist in the graph. If that is not the case, such nodes are created prior to the edge creation.

Algorithm 6: KB to Property Graph algorithm (v2)

Input: K a knowledge base**Output:** a boolean value

```

1 begin
2   g ← empty graph;
3   foreach Atom a in A do
4     create new node with id predId;
5     predId.put(label,a.predicate);
6     predId.put(arity,a.predicate.arity);
7     predId.put(type,predicate);
8     foreach Term t in a.terms do
9       if exists node with label t.label then
10        nodeId ← node.id;
11      else
12        create new node with id newId;
13        newId.put(label,t.label);
14        newId.put(variable,t.isVariable);
15        newId.put(type,term);
16        nodeId ← newId;
17      create new edge with id edgeId from nodeId to predId;
18      edgeId.put(label,pos);
19 end

```

In the second case, the graph representing the knowledge base will feature two types of nodes: terms and predicates. For each atom of the fact, a new predicate node will be created. Then, for each term of the atom, an edge from the node corresponding to the term to the newly created predicate node is created. The label of such node corresponds to the position of the term in the atom. Once again, terms nodes are verified prior to the edge creation and created if needed. In this case, the arity of the predicate is introduced in the key-value table of each predicate node.

Two graph databases are currently used within ALASKA, Neo4J and DEX. Neo4J storage model is basically build upon pointers and linked lists. Every node has an ID in Neo4J, and

the database provides a simple mapping from IDs to nodes. An edge is internally represented as a linked list, containing the IDs of the starting and ending nodes (as every edge in the graph database is binary), and the relationship type of the edge (which corresponds to our predicates). The list contains then 5 pointers: a pointer to the previous edge leading from the start node, a pointer to the next edge leading from the start node, a pointer to the previous edge leading to the end node, a pointer to the next edge leading to the end node, and a pointer to the first pair (key,value) in the key-value table of the edge. This table is implemented through a double-linked list. Searching for a node or an edge in Neo4j is done by a search algorithm that navigates through the pointers to find the requested information. As other databases, Neo4J supports external indices, such as B-trees and text-based indices for edges. Adding those indices to the core of the database has not been the priority of the developers, however.

As for DEX, the internal storage of a graph is the following. The graph is split into a combination of links and bitmaps. Every object in the graph (node or edge) has a unique ID in the database. The key-value table of nodes and edges is represented via attributes and values. A link is an internal data structure in DEX that is the combination of a map with multiple bitmaps. It ensures a bidirectional association between values and the IDs. Given a value, the link allows for example obtaining a bitmap containing the IDs of all objects containing such value. A graph in DEX features a bitmap that indexes nodes and edges by their type. As all attributes in the key-value stores must be declared prior to added to the graph, those are also indexed via a link structure. Two more links are used in order to index the incoming and outgoing edges of each node. No details on the efficiency of the bitmap compression and decompression have been given by the DEX developing staff.

5.2.3 Triples Stores

Storing a knowledge base in a triples store is very similar to performing it in a property graph-based database, as both only support binary relations natively. As for graph databases, a different encoding must be introduced in order to store knowledge bases with

predicates with arities bigger than 2. No major differences should be highlighted, excepted from the fact that as terms are only designed by URIs in a triples stores, the information of the arity of a predicate must be entered to the store by the means of a new triple containing the arity of a given predicate.

Algorithm 7 displays how a knowledge base with no restrictions on the arities of the predicates is stored in a triple store.

Algorithm 7: KB to Triples Store algorithm

Input: K a knowledge base
Output: a boolean value

```

1 begin
2   g ← empty store;
3   foreach Atom a in A do
4     foreach Term t in a.terms do
5       pos ← the position of t in a;
6       create new triple (t, alaska : pos, a.predicate);
7     create new triple (a.predicate, alaska : arity, a.predicate.arity);
8   return true;
9 end

```

The triples store used within ALASKA is Jena TDB. A TDB database corresponds to a single folder on disk. The database is composed of a table for nodes, indexes on the triples, and a table for prefixes. The table of nodes stores all the RDF terms in the database. As each RDF term is internally represented by an ID, the node table provides two mappings in order to easily obtain the ID from a node, or a node from an ID. Such mappings are particularly helpful on storage and querying processes. The triples of the database are indexed by subject, property and objects. Each of these indices contains all the information about all the triples. If this may be helpful when processing queries, this is also the cause of a certain redundancy on the data stored on disk, using more disk space than other stores. Indices and mappings are implemented with a custom implementation of the B+tree. Such im-

plementation is very similar to relational databases, with the advantage of having a native index on terms and atoms.

5.3 ALASKA operations

As previously mentioned in Chapter 4, the genericity of ALASKA relies directly on the use of the generic methods specified in the abstract layer of the platform. Writing programs, such as the backtracking algorithm presented, that have no communication with the store except using those methods ensure that the program is automatically compatible to any store integrated to ALASKA. Along with the `addAtom` function, that stores an atom to disk and has been already presented in the last section, this section will list and detail the principal functions of that abstract layer w.r.t RBDA.

A short explanation with an example of how does each of those functions is translated in each type of storage system will also be given, as it differs from one data model to another. The SQL statements given below assume that the information has been stored to the database with the storage procedure detailed in 5.2.1, where all the column names are known (col_1 to col_N). Also, one should note that the triples store used within ALASKA, Jena TDB, does provide internal functions for triples search and filtering, thus making the use of SPARQL statements for reading the knowledge base not necessary.

5.3.1 Retrieving all the atoms with a given predicate

Retrieving all the atoms with a given predicate is one of the functions that might be useful to a higher-level application using ALASKA. In this example, we show how to retrieve all the atoms with the `p` predicate in different systems.

- In a graph database, the procedure of obtaining all the atoms with a given predicate starts with the search for all the predicate nodes with such predicate. The function then asks the database whether there is a node in the database with the following

information in its key-value table: {type:predicate, label: p}. The function does not return any atom if no predicates nodes are found. If there is a match, however, the function first reads the arity information of the predicate node. We assume that the verification that the arities are respected for all atoms in the knowledge base. For each positive result, the program searches for all the terms connected to the predicate node, from 1 to the arity of p. Atom objects, as defined in ALASKA are created with the searches result.

The complexity of the operation is $\mathcal{O}(n_p)$, n_p being the number of predicate nodes of label p, for a graph database without edge type indexing, and $\mathcal{O}(n)$ otherwise, n being the size of the knowledge base.

- In a relational database, obtaining all the atoms with a certain predicate is made through a SELECT statement. One should notice that such statement is very straight-forward if the table is stored with one table per predicate in the knowledge base. The SQL statements are the following:

SELECT * FROM p (for the first algorithm presented).

SELECT * FROM tuples WHERE col_p = p (for the second one).

In both cases, the result needs to be fetched and returned as terms in ALASKA model. In the first case, the rows returned will be read, and for each term, the vars table will have to be accessed in order to check if a returned term is variable or not. Same thing for the second case, where the information will be obtained by checking the prefix of the term.

The complexity of the operation in a database with an index on predicates is $\mathcal{O}(m)$, m being the number of tuples in table p, $\mathcal{O}(n)$ otherwise.

5.3.2 Listing the terms connected to a given term with a given predicate

Listing the terms connected to a given term requires, besides a term, a predicate and two terms positions to be passed as input. The first term position indicates the position of the given term in the atom, while the second one indicates which term of the atom

in the knowledge base to return. There is always the possibility of returning the whole atom, however this is not our aim. This function corresponds to the enumerate function previously presented in Chapter 4. As example, we will show how to retrieve all the terms connected to a , the second term of the atom, via the p predicate that are at first position in the atom. The function focus in the position of the term to retrieve and thus does not consider the arity of the predicate (of course, the requested position must be lower or equal to the arity of the predicate). In the case that p is a binary predicate, the function returns all the X such that $p(X, a)$ exist in the knowledge base. If for instance, p is a predicate of arity 4, it would return all the X such that $p(X, a, ?, ?)$ is in the knowledge base.

- In a graph database, the listing of all the X terms connected to a via the p predicate, at first position of the atom is computed by the following program. It first selects the term node corresponding to the a term. If it is found, the program will now check if there is an edge of label 2 between the selected node and a predicate node with label p . For all results, the program will search for the term connected to the predicate node by an edge of label 1. The label will be memorized, inserted into a Term object as defined by ALASKA, and pushed to a collection. The list of candidates is then returned by the program.

The complexity of the operation in a graph database is $\mathcal{O}(|a_n|)$, a_n being the size of the neighbourhood of a .

- In a relational database, finding such a list of candidates is made through a SELECT statement where one element of the row is instantiated, and only one is wanted in return. In order to find all the X for the $p(X, a)$ atom, the SQL statements are the following (according to the manner the knowledge base is stored in the database):
 SELECT col₁ FROM p WHERE col₁ = 'a' (for the first algorithm presented).
 SELECT col₁ FROM tuples WHERE col_p = p AND col₂ = 'c : a' (for the second one).
 The result also needs to be fetched and returned as terms in ALASKA model, and the procedure is done exactly as for the previous operation.

The complexity of the operation in a database with an index on predicates is $\mathcal{O}(m)$, m being the number of tuples in table p , $\mathcal{O}(n)$ otherwise.

5.3.3 Verifying the existence of a given atom

Verifying the existence of a given atom corresponds to the other elementary operation of the backtracking algorithm for computing homomorphisms presented in 4. This function is also referred as the check function. We will use the atom $p(a, b, c)$ as example, where a , b and c are constants.

- In a graph database, the procedure of verifying if $p(a, b, c)$ starts with the search for the predicate node. The function first asks the database whether there is a node in the database with the following information in its key-value table: {type: predicate, label: p , arity: 3}. For each positive result (as there can be more than one), the program will now check if all the nodes corresponding to the terms are correctly connected to this predicate node. In the case of the atom $p(a, b, c)$, the program asks the database if there is a node of type term and label a connected to the predicate node, and if such edge has its label 1. If that is not the case, the predicate node is discarded and the program tests another predicate node. If yes, the program verifies the b and c term nodes. If the edges between all the terms nodes and the predicate node are correct, the atom is found and the program returns a positive answer. If no positive match is found for all the predicates nodes tested, the atom was not found and the program returns a negative answer. The complexity of the operation in a database without an index on the predicate is $\mathcal{O}(n_p)$.
- In a relational database, the verification of an atom is made through a SELECT statement where all the elements of the query are instantiated. For the $p(a, b, c)$ atom, the SQL statements are the following (according to the manner the knowledge base is stored in the database):
 SELECT * FROM p WHERE $col_1 = 'a'$ AND $col_2 = 'b'$ AND $col_3 = 'c'$ (for the first al-

gorithm presented).

```
SELECT * FROM tuples WHERE colp = p AND col1 = 'c : a' AND col2 = 'c : b' AND  
col3 = 'c : c' (for the second one).
```

In both cases, there is no need to fetch and read the results obtained. Executing the SQL operation will return an iterator, and the answer of whether the atom is found or not can be given by verifying if the iterator is empty or not.

The complexity of the operation in a database with an index on predicates is $\mathcal{O}(m)$, m being the number of tuples in table p , $\mathcal{O}(n)$ otherwise.

5.4 Input Data

In order to perform our experimental work, knowledge bases had to be selected for our protocol. The knowledge base we have used has been introduced by the SP2B project [Schmidt *et al.*, 2008]. The SP2B project supplies a generator that creates arbitrarily large knowledge bases maintaining a similar structure to the original DBLP¹ knowledge base, which they have studied. The argument of the project members for choosing DBLP is that it reflects the social network character of the Semantic Web, where many small pieces of information are put together, creating a global network of data. The generated knowledge bases are in RDF format (N-TRIPLES format), although our testing protocol within the ALASKA platform uses logical expressions as input to the system. Using those generated knowledge bases then require an initial translation from RDF into first order logic expressions. The use of the SP2B knowledge bases is relevant to this work since:

- logical knowledge bases are not easily available throughout the web.
- this kind of knowledge bases seem to be very similar to all the emergent knowledge bases that have appeared with Social Networks and the Semantic Web, in which it would be highly recommended to perform RBDA.

1. <http://www.informatik.uni-trier.de/ley/db/>

5.5 Storage

Storing information on disk may come into play in two different steps of RBDA. The first is when one has to load a knowledge base and decides to store it locally in a particular system. The second is when a rule application process is launched and the process generates brand new information to be added to the current fact. While in the first case speed is not that relevant, as it could be considered a pre-processing step and often is only needed once, it is crucial for the second. In this section we present in detail our experimental work on storage efficiency.

5.5.1 Workflow

Let us consider the workflow used by ALASKA in order to store new facts. The fact will first be parsed in the application layer (1) into the set of atoms corresponding to its logical formula, as defined in the abstract layer (2). Then, from this set, a connector located in layer (3) translates the fact into a specific representation language in (4). The set of atoms obtained from the fact will be translated into different data models.

In this workflow, the RDF file is given as input to the Input Manager in the application (layer 1). Information is then forwarded according to the selected output system. The fact from file is first transformed in an IFact object (layer 2). It is then translated (layer 3) to the language of the system of choice (graph, relational database, or triple store) before being stored onto disk (layer 4). This workflow is visualised in Figure 5.1 where a RDF file is stored into different storage systems.

5.5.2 Challenges

Storing large knowledge bases using a straight-forward implementation of the testing protocol has highlighted different issues. We have distinguished three different issues that have appeared during the tests: (1) memory consumption at parsing level, (2) use of

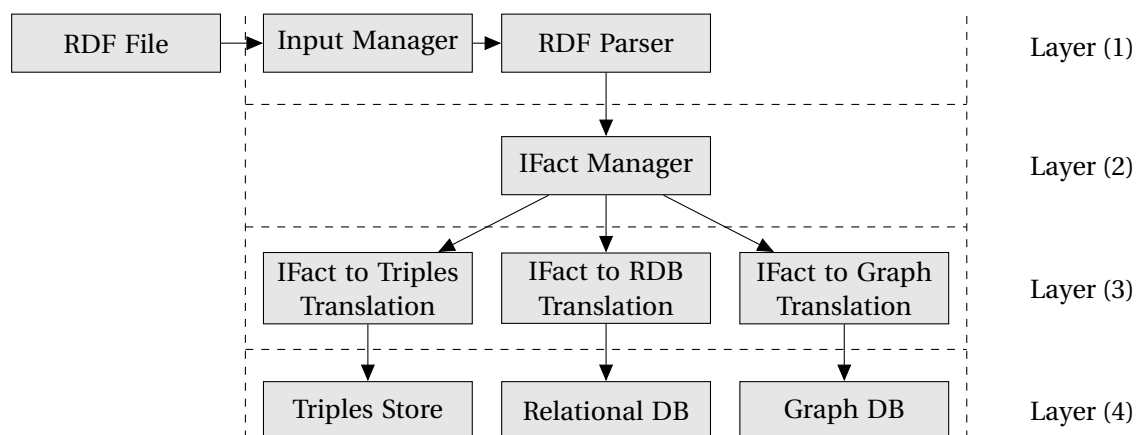

Figure 5.1: Workflow for storing a knowledge base in RDF using ALASKA.

transactions, and (3) garbage collecting time.

Memory consumption at parsing level depends directly of the parsing method chosen. A few experiences have shown that some parsers/methods use more memory resources than others while accessing the information of a knowledge base and transforming it into logic. We have initially chosen the Jena framework parsing functions in order to parse RDF content, but we have identified that it loads almost the whole input file in memory at reading step. We have thus replaced the RDF parser to a different one, which works only with N-Triples encoded RDF files, that does not store the facts in main memory but feeds them one at a time to the ALASKA.

Garbage collecting (GC) issues have also appeared as soon as preliminary tests were performed. Several times, storing not very large knowledge bases resulted in a GC overhead limit exception thrown by the Java Virtual Machine. The exception indicates that at least 98% of the running time of a program is consumed by garbage collecting.

Managing **transactions** also became necessary in order to reduce the loss of efficiency obtained in the preliminary tests. As we work with different storage methods, their

transaction management systems also differ. While it is needed to manage transactions manually in certain systems, transactions are enabled by default in others, thus needing to be explicitly handled in order to obtain success. Tests have shown that trying to store all the atoms of a knowledge base at once in a single transaction was effective up to a certain point, and inefficient beyond this point as the transaction content is kept in memory until the transaction is committed or discarded. In order to avoid too much memory consumption, we have decided to run multiple transactions while storing a large knowledge base on disk.

In order to address both transaction and garbage collection issues, a buffer of atoms was set up. The buffer is filled with freshly parsed atoms at parsing level. At the beginning, the buffer is full and then every parsed atom is pushed into the buffer before being stored. Once the buffer is full, parsing is interrupted and the atoms in the buffer are sent to the storage system for being stored. Once all atoms are stored, instead of cleaning the buffer by destroying all the objects, the first atom of the buffer is moved from the buffer into a stack of atoms to be recycled. Different stacks are created for each arity of predicates. In order to replace this atom, a new atom is only created if there is no atom to be recycled from the stack of the arity of the parsed atom. If there is an atom to be recycled, then it is then put back in the buffer, with its predicate and terms changed by attribute setters. The buffer is then filled once again, until it is full and the atoms in it are sent to storage system.

5.5.3 Contribution

In order to store large knowledge bases on disk using a single machine, preventing the issues described above, we have implemented the storage algorithm of Figure 8. The algorithm is run by an `InputManager` class within ALASKA that handles all the storage calls from users.

Algorithm 8 illustrates the manner the Input Manager handles a stream of atoms received as input. Other parameters passed as input are the fact where the stream of atoms must be stored, and an integer representing the size of the buffer of atoms that will be

Algorithm 8: Input Manager storage method

Input: S a stream of atoms, f an $I\text{Fact}$, $b\text{Size}$ an integer**Output:** a boolean value

```
1 begin
2   buffer  $\leftarrow$  an empty array of size  $b\text{Size}$ ;
3   counter  $\leftarrow$  0;
4   foreach  $Atom\ a\ in\ S\ do$ 
5     if counter =  $b\text{Size}$  then
6       f.addAtoms(buffer,null);
7       counter  $\leftarrow$  0;
8     buffer[counter] = a;
9     counter++;
10  f.addAtoms(buffer,counter); return true;
11 end
```

instantiated. The buffer along with a counter are created at the beginning of the procedure. The procedure is very simple, as it puts the atoms of the stream in the buffer until its capacity is reached. The buffer, full of atoms is then sent to the storage system that manages the fact f . This is made through the `addAtoms` method, implemented in each store connected to ALASKA.

The solution of using a buffer has been chosen after solutions storing atoms one-by-one has shown to be very inefficient, and all-at-once solutions would load the whole transaction content in memory, going beyond the limit of memory usage for such process.

5.5.4 Results

As previously mentioned, the SP2B project supplies a generator that creates knowledge bases with a certain parametrised quantity of triples maintaining a similar structure to the original DBLP knowledge base. The generator was used to create knowledge bases of increasing sizes (5 million triples, 20, 40, 75 and respectively 100). Each of the knowledge

bases has been stored in Jena, DEX, SQLite and Neo4J. In Figure 5.2 we show the time for storing the knowledge bases and their respective sizes on disk.

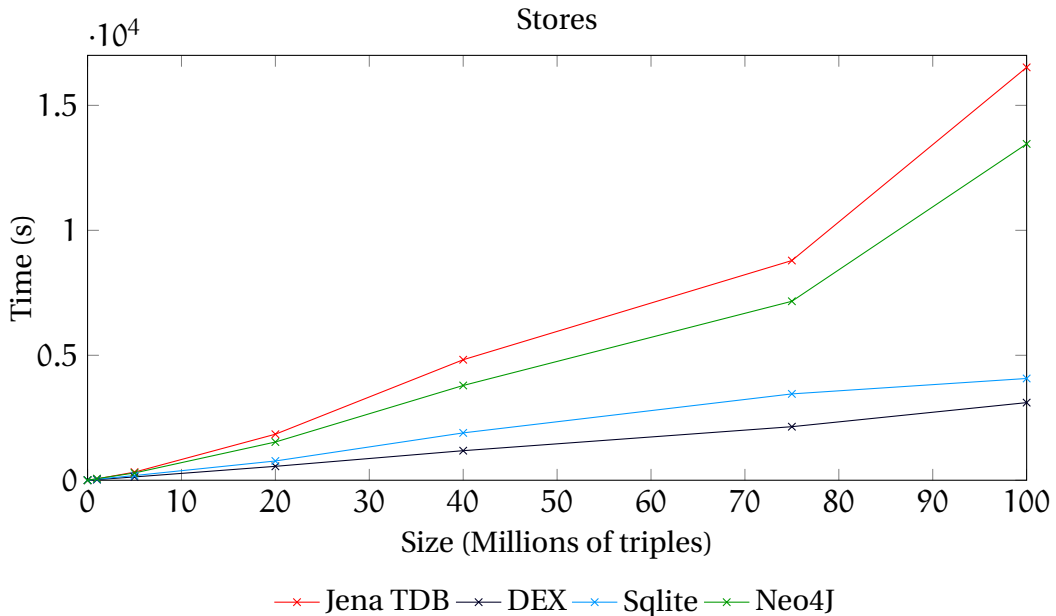

Figure 5.2: Storage time and KB sizes in different systems

The user can see that the behaviour of Jena is worse than the other storage systems. Let us also note that DEX behaves much better than Neo4J and this is due to the fact that ACID transactions are not required for DEX (while being respected by Neo4J). Second, the size of storage is also available to the user. One can see, for instance, that the size of the knowledge base stored in DEX and Neo4J is well under the size of initial RDF file. However, the size of the file stored in Jena is bigger than the one stored in SQLite and bigger than the initial size of the RDF file.

The storage tests were performed on a dedicated server with the following characteristics: 64-bit Quadcore AMD Opteron 8384 with 512 Kb of cache size and 64 Gb of RAM. Please note that this second server is shared between multiple processes, therefore the tests will only use part of all this computing power. The memory size of the JAVA Virtual Machines created for executing the testing processes was of 4Gb.

Size of the stored knowledge bases					
System	5M	20M	40M	75M	100M
DEX	55 Mb	214.2 Mb	421.7 Mb	785.1 Mb	1.0 Gb
Neo4J	157.4 Mb	629.5 Mb	1.2 Gb	2.3 Gb	3.1 Gb
Sqlite	767.4 Mb	2.9 Gb	6.0 Gb	11.6 Gb	15.5 Gb
Jena TDB	1.1 Gb	3.9 Gb	7.5 Gb	13.9 Gb	18.1 Gb
RDF File	533.2 Mb	2.1 Gb	4.2 Gb	7.8 Gb	10.4 Gb

Figure 5.3: Storage time and KB sizes in different systems

5.6 Querying

Performing queries is at the heart of the RBDA problem. It is needed when no ontological content is present to enrich facts, and also present in both methods of rule application we have explained in Chapter 2. Unlike storage, querying efficiency does not rely only on the storage systems, but in a triplet composed of storage systems, querying method and also the queries chosen. After a first battery of tests, in which neat conclusions were difficult to obtain, we have focused in the adaptation of our problem into a CSP problem and the integration of a CSP solving program in order to address conjunctive query answering. In this section we present in detail our experimental work on querying.

5.6.1 Workflow

Querying tests within our architecture takes place as indicated in Figure 5.4. Queries entered in ALASKA are processed and handled by the generic algorithms present in ALASKA, or translated to different querying languages according to the user's choice. As discussed in 3 and seen in the picture, a fact stored in a property graph-based database can only be queried in ALASKA using a generic querying algorithm. In addition to the backtracking algorithm described in Section 4.4, a CSP solving algorithm was also designed for answering conjunctive queries. More details about this solution are given in Section 5.6.3. Facts stored in a relational database can of course still be queried via the native SQL interface of the database, and fact stored in a triples store can also be queried using the

native SPARQL interface of the store.

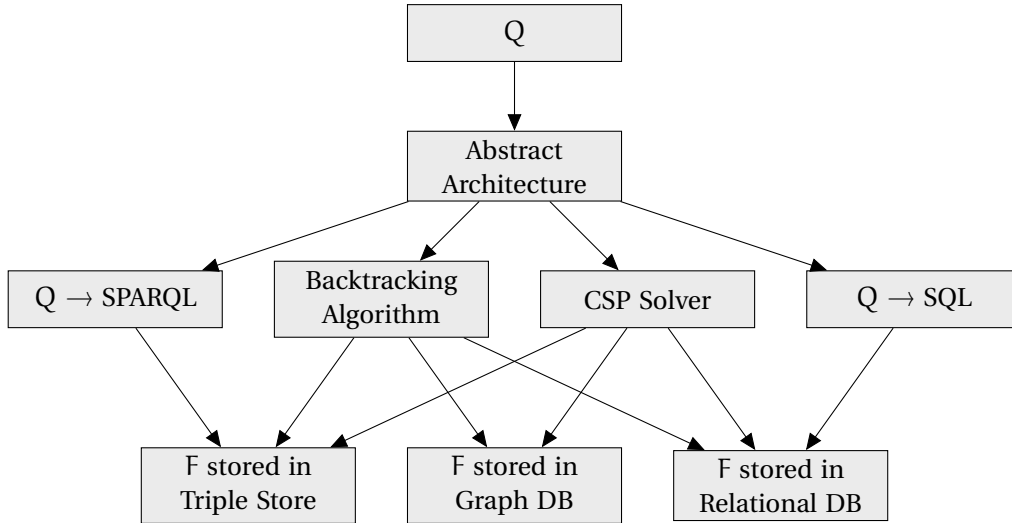

Figure 5.4: ALASKA storage and querying workflow.

5.6.2 Results

We have tested all the systems previously listed in Section 4.5 with the generic backtracking algorithm detailed in Section 4.4 as well as the native query engines when available for each system. The knowledge bases used for the tests were generated using the same data generator already used for the storage tests. The queries used for the tests are the following:

1. $\text{type}(X, \text{Article})$

Returns all the elements which are of type article.

2. $\text{creator}(X, \text{PaulErdoes}) \wedge \text{creator}(X, Y)$

Returns the persons and the papers that were written with Paul Erdoes.

3. $\text{type}(X, \text{Article}) \wedge \text{journal}(X, \text{Journal1-1940}) \wedge \text{creator}(X, Y)$

Returns the creators of all the elements that are articles and were published in Journal 1 (1940).

4. `type(X,Article) ∧ creator(X,PaulErdoes)`

Returns all the articles created by Paul Erdoes.

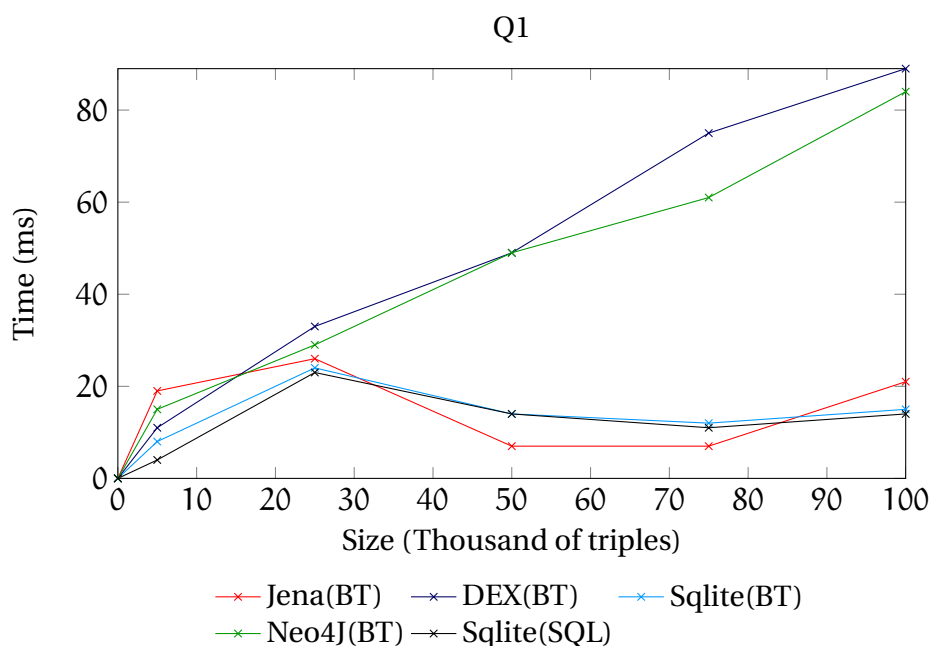

Figure 5.5: Querying efficiency results for query 1.

The queries in the set were slightly inspired from the queries featured in the SP2B project [Schmidt *et al.*, 2008]. However, the queries featured in the paper were designed with the purpose of covering all the features of the SPARQL query language, which is not our goal here. As we only deal with conjunctive queries, we have removed and also modified some queries in the set in order to have a set of queries that would be relevant for our purposes. We also state that such queries could have been executed in real-use case such as querying for articles and their properties in a bibliography management system such as DBLP. The queries were executed over knowledge bases of 5, 25, 50, 75, and 100 thousand triples.

The results presented above have shown the behaviour of the different storage systems integrated to ALASKA against a set of queries manually input. We notice that systems

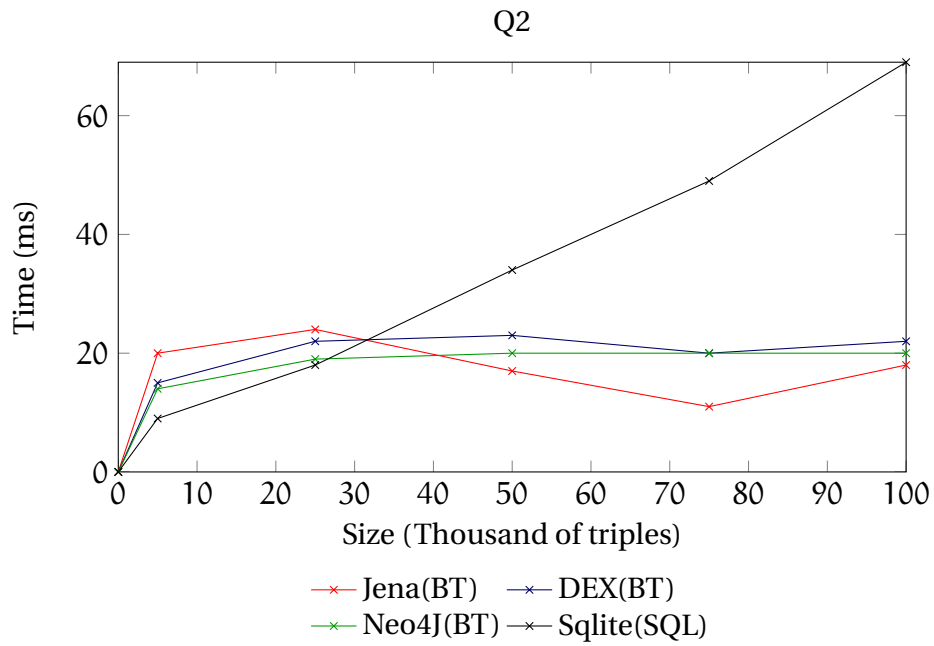

Figure 5.6: Querying efficiency results for query 2.

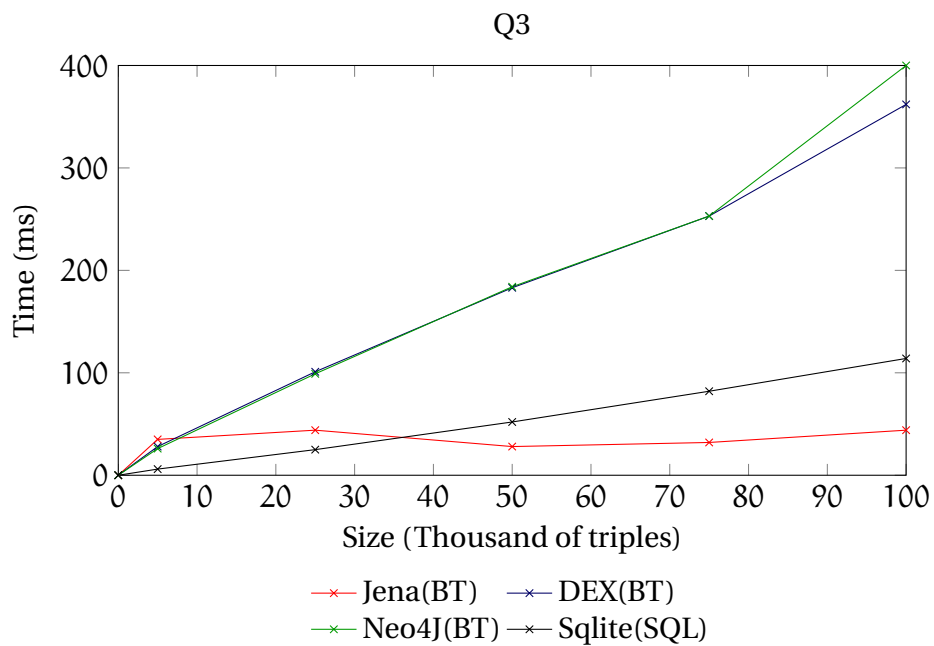

Figure 5.7: Querying efficiency results for query 3.

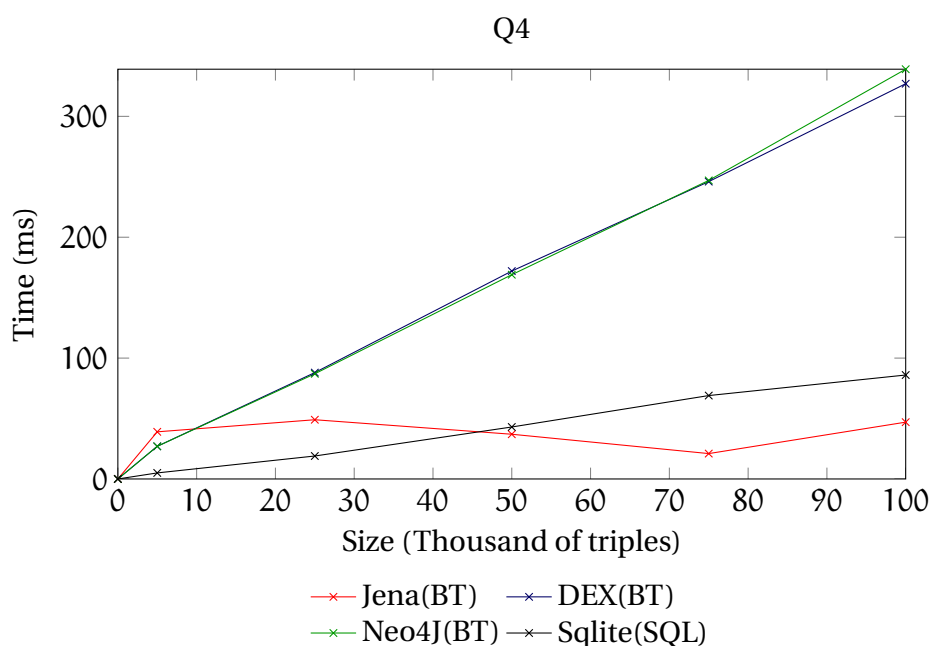

Figure 5.8: Querying efficiency results for query 4.

behave differently against different queries. This is due to the fact that each query differs from the others according to its structure, number of calls to the elementary operations (enumerate, check) and number of answers in the knowledge base.

We observe in the results that Jena TDB has shown to be efficient in all cases. For the only query it has not been the fastest system to answer, its response time was still very close from the fastest ones. We note that the querying efficiency of Jena TDB is linked to the efficiency of the index structures the system automatically builds at storage. Improving its querying efficiency by increasing the disk usage might be a good solution for an use case in which disk usage is not a constraint.

We also observe that independently of the internal data structure, both graph databases have almost the same efficiency for all the queries. Using a SQL engine has shown to be less efficient than using a backtracking algorithm for Q2. In this query, the number of answers is fixed, as no new papers from Paul Erdoes appear after a certain time. As the backtracking

algorithm over a graph database explores the neighbourhood of the Paul Erdoes term, the answering time of the query in this case will remain constant even on a larger knowledge base. On the other hand, the SQL engine has to join the creator table with itself, and as the size of the table grows fast, the answering time of the engine for this query also grows. Using a backtracking algorithm has however shown to be less efficient for the other queries.

We have seen that a backtracking algorithm can be a good solution on instances in which a join algorithm does not perform well. However, the behaviour of the backtracking algorithm we have implemented on knowledge bases under a million triples has raised the question on how to optimize this backtracking algorithm. As using an SQL engine has shown to be efficient enough for simple queries, we look forward optimizing the backtracking algorithm for complex queries.

Optimizing the backtracking algorithm can be done in two different manners. First, in a technical point of view, it is possible to verify whether internal data structures used by the algorithm are adequate and offer a good complexity for the operations required by the program. Also, there are today libraries that propose new and optimized implementations of the native data structures in JAVA. Second, at algorithmic level, several proposals for optimizing the backtracking algorithm are available in the literature [Baget, 2001]. Most of those have been studied in the constraint domain.

5.6.3 CSP

Instead of implementing all the available algorithmic optimizations, we have rather preferred to adapt our problem into a constraint satisfaction problem. The reason of this choice is twofold. First, in an algorithmic point of view, is that most of these existing optimizations are already available in the CSP solvers. Second, the integration of a CSP solver within ALASKA, added to a well written adaptation of our data access problem to a constraint satisfaction problem would ensure that the updates and optimizations to the solver program would make our instances of the problem benefit of such updates without

having to change our implementation.

A constraint satisfaction problem is a triple (X, D, C) , where X is a set of variables, D is a domain of values, and C is a set of constraints. Every constraint $c \in C$ is in turn a pair (t, R) where t is a n -tuple of variables and R is an n -ary relation on D . An evaluation of the variables is a function from the set of variables to the domain of values, $v : X \rightarrow D$. An evaluation v satisfies a constraint $((x_1, \dots, x_n), R)$ if $(v(x_1), \dots, v(x_n)) \in R$. A solution is an evaluation that satisfies all constraints.

In order to integrate a CSP solver within ALASKA, we have chosen the Choco [Jussien *et al.*, 2008] solver. The fact that it has a complete documentation available on the web and that it is written in JAVA have guided our choice. Finally, for our problem, which can be considered particular in the CSP domain, the availability of the developers of Choco have helped confirming our choice. We have defined two different manners to adapt our problem into a CSP problem. The first manner concerns knowledge bases that can be entirely loaded in main memory. It has been later modified and extended to large knowledge bases, which is the second manner we have defined.

Simple transformation to CSP

Transforming the entailment problem into a CSP problem is quite simple when the knowledge base one wants to deduce a fact from is small enough to be entirely loaded in main memory. The procedure of transformation is the following:

- The network is composed of variables and constraints between the variables. Each variable has a domain. The domain of a variable contains the possible values for that variable. In the representation of our problem, the variables of the network correspond to the terms of the query Q , while the constraints will feature the list of tuples that satisfy the given constraint. Each constraint corresponds to an atom of Q .

- No information about the values in the variables' domains is known at start. Hence, all the variables are instantiated with all the available integer values. (It is always possible to filter the domain of a variable manually during the solver execution, but it is impossible to add a value to the domain.)
- Constraints are added to the network once all the variables have been defined. One constraint is created for each atom of Q . For each constraint, the variables connected to this new constraint are all the variables corresponding to the terms of the atom the constraint represents. The list of authorized tuples for this constraint is then read in the knowledge base. Such proceeding can not be used when dealing with a larger knowledge base, as computing all the authorized tuples may lead the computer to run out of memory.
- The solver can now be run once the variables and constraints have been properly instantiated.

Note that as the Choco library only manipulates integer values, each term in the knowledge base has to be represented by an integer. Key-value stores will then be used by the system to retrieve a term by its integer identifier and vice-versa. Filling such key-value stores depends on the size of the knowledge base. In the case of a small knowledge base, it can be done as a preprocessing step prior to creating the network.

Transformation with large KBs

As previously mentioned, some things presented in the previous section changed, and the problem receives an additional difficulty when dealing with large knowledge bases. One of the important changes is that it becomes forbidden to perform any operation having its complexity depending on the size of the knowledge base. This is the reason why a different transformation of our problem into a CSP problem had to be designed, since it is now needed to be able to indicate that a variable, at instantiation time,

contains all the possible values in the knowledge base without having to compute them all.

The method chosen to address this problem came with the technical limitations of the Choco library itself. Indeed, Choco maintains the information concerning the variables' domains in memory, and keeps track of the evolution of those values for the eventuality of backtracking during the solver execution. The fact of keeping track of all this information in memory introduces a physical limit to the size of a domain. According to our preliminary tests with Choco, the limit of values in the domain of a variable in Choco is around 35000 values. As we have not found any mature idea on how to bypass such technical constraint, we will remain under such technical limit for this work.

One should not forget that this number of 35000 values in a domain does not mean that we will be limited to knowledge bases with 35000 terms or less (as such size of knowledge base fits perfectly in main memory) but rather that it will restrain every term of the query (each variable in the network) to explore only 35000 terms of the knowledge base during the execution of the solver. Indeed, the knowledge base size forbids us to precompute all the lists of authorized tuples for each constraint in the network. Such procedure will now be performing at solving stage, and only in certain conditions, in order to avoid performing too many reading operations in the knowledge base.

In this case, instead of having the key-values stores shared between all the variables of the network, each variable will have its own key-values tables. The values in this tables will be affected at runtime, and, this, a term in the knowledge base may have two different integer identifiers in two different variables. It will be the task of the propagation function inside the constraints to maintain the coherence between terms and the integer identifiers of such terms in all the variables connected to a constraint. The procedure of transforming a conjunctive query over a large knowledge base in a CSP problem is the following:

- To begin with, the terms of the knowledge base will not be read prior to the solver

execution, excepted the constant terms in the query. This is due to the fact that a constant term in the query can only be matched to the same constant in the facts. Looking for the constants in the knowledge base may save time in the case one of them does not exist in the knowledge base. For each constant in the query, its matching in the knowledge base will be given the first integer value in the domain of the variable. A constraint of equality is linked to the variable, to indicate that this is the unique possible value for the variable.

- Once this is done, all the variables of the network corresponding to the non-constant terms of the query are initialized, with a domain going from 1 to 35000. This is performed without reading the knowledge base. The constraints are then created and attached to the variables. As for the variables, they will also be created but no knowledge base information will be read at this time. The only information they will carry upon initialization are the predicate of the corresponding atom and an integer value that will serve as a threshold for triggering a propagation sequence.
- The solver is ready to be run once all the variables and constraints of the network are properly created and "instantiated". In this version, as no information from the knowledge base was read into the network, the solver will not find any answer to the query when launched.
- Finding an answer to the query will only be possible through a propagation mechanism, that will enable the solver to filter the domains of the variables. The propagation is a function located in the constraint class that indicates to the solver how to proceed for finding answers. The behaviour of the propagation method we have implemented is to consult the knowledge base for retrieving information once the size of the domain of a variable attached to the constraint is lower than the threshold value set for this constraint. The bigger this value, the bigger are the chances for triggering the propagation. As the domains of all the variables of the network are not

filtered at launch (and consequently higher than any threshold), this solution only covers conjunctive queries with at least one constant for now. The presence of the constant in the query ensures that at least one propagation call is performed, as the size of the domain of the variable is reduced to 1 at launch. This is a temporary solution that will be upgraded later with the use of more efficient indexation techniques.

- The knowledge base is read once the propagation function of a constraint of the network is triggered. The authorized tuples for this constraint will be computed then added to constraint information. This will filter the domains of the variables connected to the constraint. The efficiency of this solution comes from the fact that the propagation function does not read the whole knowledge base, but only looks for the neighbourhood of certain terms. This is due to the `enumerate` function, already used in the generic backtracking algorithm and described in Section 5.3.
- Filtering the domain of the variables connected to a constraint should trigger the propagation function in another constraint, until all the lists of authorized tuples needed are computed. Once this happens, the solver can find the answers of the query in the knowledge base. If the propagation sequence stops before all the constraints have their list of tuples computed, this means that all the previous propagations have not filtered the remaining domains enough to reach the threshold value. This case is discussed in Section 5.6.3.

Discussion

Despite the fact that the propagation mechanism for answering conjunctive queries using a constraint satisfaction solver when the knowledge base is very large has been successfully implemented, we have not succeeded in adding it to the list of querying methods in our testing protocols. The reason for this comes to the fact of the CSP solver not knowing how to proceed once the propagation sequence stops. The larger the knowledge base, more are the number of terms in the domain of each variable, making the threshold value

more difficult to reach. Of course, it is always possible to increase such value manually prior to the solver execution, however not only it is impossible to know in advance which value to choose, but it also increases the amount of information read from the knowledge base and loaded in memory by the network. Another strategy for this cases is to pause the solver and to filter manually the domains of the variables of a given constraint, according to information of the knowledge base. If one has information about the frequency of predicates or some index on the knowledge base, he could use it in order to help the solver once his propagation sequence does not help it anymore to filter the domain of the variables in the network. Such ideas will be discussed in Section 6.3.3.

Conclusion

One of the most important things one can do in life is to brutally question every single thing you are taught.

B. MCGILL

6.1 Conclusion

This thesis presented our contribution to provide a unified platform for addressing the RBDA problem. In Chapter 2, we presented the problem addressed in the thesis, introducing the formalism used and explaining the challenges of the problem. In Chapter 3, we have listed different existing approaches according to their native ability of querying knowledge bases with the presence of an ontology and also their support to external data. In Chapter 4, we introduced the ALASKA platform, a software architecture designed and implemented during this thesis, enabling users to perform higher-level reasoning operations over heterogeneously stored knowledge bases. Finally, in Chapter 5, after having

explained how we aimed to use ALASKA to address the RBDA problem, we showed internal details of the implementation of ALASKA, along with the testing protocols of storage and querying efficiency of the storage systems integrated within ALASKA.

This section concludes this thesis by stating the research achievements of my work (Section 6.2), then discussing my contribution in the context of the open questions this work has posed (Section 6.3).

6.2 Research Achievements

In Chapter 1, we stated the following research question: ***“How to provide a platform providing under a unified logical framework different implementation approaches for addressing the rule based data access problem?”***

This work has answered the above research question and the research achievements of this thesis are:

- A framework unifying different implementation approaches by the means of a common logical vision.
- A generic and logic-based software architecture allowing the communication to different storage systems through an unified language.
- The ability of using such architecture to write higher-level reasoning programs independently of how the data to be manipulated is stored.
- An algorithm that enables the storage of a very large knowledge base on disk in a single machine and avoids full memory consumption.
- The transformation of the problem of querying a knowledge base into a constraint solving problem and its adaptation to large knowledge bases.

6.3 Discussion

This section presents interesting open research problems triggered by this work that remain to be studied and developed in the future.

6.3.1 ALASKA

In this thesis, we have presented ALASKA, the software architecture we have designed and we have used to study the efficiency of existing storage systems for the elementary operations of conjunctive query answering. As previously stated, the ALASKA framework allows to build the first layer of an ambitious research aim, a generic platform for RULE-BASED DATA ACCESS. This first layer concerned the storage and querying operations that such generic platform must use during the reasoning process.

The future work paved by this thesis can be roughly divided in three parts:

- Expressivity
- Efficiency
- Decentralization

6.3.2 Expressivity

In this thesis, we considered the backwards and forward chaining algorithms as intuitions for our storage and querying requirements. However, we did not consider the case in which the expressivity of the rules asks for the removal of atoms from the knowledge base. As a simple example, if we consider non-monotonic reasoning with rules such as default rules or answer set programming, such functionality is required.

Investigating considered storage structures from this perspective is an important aspect to be considered in the future.

6.3.3 Efficiency

As previously stated in Section 5.6.3, the propagation strategy of the CSP when dealing with large knowledge bases is the following: reading the knowledge base in order to look for a specific information only happens once a variable in the network has its domain size under a certain threshold. This value is set initially and can easily be modified. Once the size of the domain of a variable gets under the threshold, then the code contained inside the constraint classes calls the `enumerate` method, which filters the domain of the neighbouring variables.

Such strategy has a major known drawback, which is the fact that the solver does not have an idea on how to proceed when there is no propagation to execute. This happens for example when launching the solver, as all the domains of the variables are full at that moment. For this reason we have been restricted to performing queries containing at least one constant term. This reduces the domain of the variable of the constant term to a single value, which is lower than any threshold value set, and launches the propagation.

However, if one wants to avoid the solver to be stuck during its execution or to handle queries with no bootstrap (no constant terms in the query), a better solution would need to be designed. The major idea in order to have this solved would be to add indexing features to the CSP solver, enabling it to read an index or some knowledge base statistics about terms or predicates once the propagation sequence is not enough for finding an answer.

6.3.4 Decentralization

One of the main advantage of having a generic platform for `RULE-BASED DATA ACCESS` is the possibility of having several decentralized knowledge bases that we can jointly query in a transparent manner. In order to fully exploit this advantage, automatic translation procedures from different languages used in KR (Datalog, FOL, Prolog, Conceptual Graphs,

Semantic Web languages, Description Logics, etc.) have to be integrated into ALASKA.

Such procedures will not only require a tight adherence to the standard considered but also technical issues (as seen in Chapter 5) that could be addressed using buffering or other techniques.



Bibliography

Serge Abiteboul : Semi-structured data. *In Encyclopedia of Database Systems*, pages 2599–2601. 2009. Cited pages 26 and 27.

Serge Abiteboul, Richard Hull et Victor Vianu : *Foundations of Databases*. Addison-Wesley, 1995. ISBN 0-201-53771-0. Cited pages 9 and 33.

Franz Baader, Sebastian Brandt et Carsten Lutz : Pushing the EL envelope. *In International Joint Conference on Artificial Intelligence (IJCAI)*, pages 364–369, 2005. Cited page 9.

Jean-François Baget : *Représenter des connaissances et raisonner avec des hypergraphes : de la projection à la dérivation sous contraintes*. Thèse de doctorat, 2001. Cited page 93.

Jean-François Baget : Rdf entailment as a graph homomorphism. *In International Semantic Web Conference*, pages 82–96, 2005. Cited page 20.

Jean-François Baget, Michel Leclère et Marie-Laure Mugnier : Walking the decidability line for rules with existential variables. *In International Conference on Principles of Knowledge Representation and Reasoning (KR)*, 2010. Cited page 18.

- Jean-François Baget, Michel Leclère, Marie-Laure Mugnier et Eric Salvat : On rules with existential variables: Walking the decidability line. *Artif. Intell.*, 175(9-10):1620–1654, 2011a. Cited pages 17 and 22.
- Jean-François Baget, Marie-Laure Mugnier, Sebastian Rudolph et Michaël Thomazo : Walking the complexity lines for generalized guarded existential rules. In Toby Walsh, éditeur : *Proceedings of the 22nd International Joint Conference on Artificial Intelligence (IJCAI-2011)*, pages 712–717. IJCAI / AAAI, 2011b. Cited page 9.
- Jean-François Baget et Eric Salvat : Rules dependencies in backward chaining of conceptual graphs rules. In *International Conference on Conceptual Structures (ICCS)*, pages 102–116, 2006. Cited page 17.
- Christian Bizer, Tom Heath et Tim Berners-Lee : Linked data - the story so far. *Int. J. Semantic Web Inf. Syst.*, 5(3):1–22, 2009. Cited page 27.
- Andrea Cali, Georg Gottlob et Thomas Lukasiewicz : A general datalog-based framework for tractable query answering over ontologies. In *Proceedings of the Twenty-Eighth ACM SIGMOD-SIGACT-SIGART Symposium on Principles of Database Systems*, pages 77–86. ACM, 2009. Cited pages 2, 9, and 49.
- Andrea Cali, Georg Gottlob, Thomas Lukasiewicz, Bruno Marnette et Andreas Pieris : Datalog+/-: A family of logical knowledge representation and query languages for new applications. In *LICS*, pages 228–242, 2010. Cited page 9.
- Diego Calvanese, Giuseppe De Giacomo, Domenico Lembo, Maurizio Lenzerini et Riccardo Rosati : Tractable reasoning and efficient query answering in description logics: The DL-Lite family. *J. Autom. Reasoning*, 39(3):385–429, 2007. Cited page 9.
- Michel Chein et Marie-Laure Mugnier : *Graph-based Knowledge Representation: Computational Foundations of Conceptual Graphs*. Advanced Information and Knowledge Processing. Springer, 2009. Cited pages 9, 13, and 36.

- William F. Clocksin et Christopher S. Mellish : *Programming in Prolog (4. ed.)*. Springer, 1994. ISBN 978-3-540-58350-9. Cited pages 26 and 30.
- Edgar F. Codd : A relational model of data for large shared data banks. *Commun. ACM*, 13 (6):377–387, 1970. Cited page 28.
- Madalina Croitoru : *Conceptual Graphs at Work: Efficient Reasoning and Applications*. Thèse de doctorat, University of Aberdeen, 2006. Cited page 2.
- Madalina Croitoru et Ernesto Compatangelo : A tree decomposition algorithm for conceptual graph projection. *In Tenth International Conference on Principles of Knowledge Representation and Reasoning*, pages 271–276. AAAI Press, 2006. Cited page 13.
- Madalina Croitoru, Léa Guizol et Michel Leclère : On link validity in bibliographic knowledge bases. *In Information Processing and Management of Uncertainty in Knowledge-Based Systems (IPMU 2012)*, pages 380–389, 2012. Cited page 66.
- Bruno Paiva Lima da Silva, Jean-François Baget et Madalina Croitoru : A generic platform for ontological query answering. *In SGAI International Conference on Artificial Intelligence (AI-2012)*, pages 151–164, 2012. Cited page 47.
- David Genest et Eric Salvat : A platform allowing typed nested graphs: How cogito became cogitant (research note). *In International Conference on Conceptual Structures (ICCS)*, pages 154–164, 1998. Cited page 26.
- Olivier Guinaldo et Ollivier Haemmerlé : Cogito : une plate-forme logicielle pour raisonner avec des graphes conceptuels. *In Informatique des Organisations et Systèmes d'Information et de Décision (INFORSID 1997)*, pages 287–306, 1997. Cited page 35.
- Patrick Hayes : Rdf model theory. Rapport technique, Technical report, W3C Working Draft, 2001. Cited page 20.
- Patrick Hayes, éditeur. *RDF Semantics*. W3C Recommendation. W3C, 2004. <http://www.w3.org/TR/rdf-mt/>. Cited pages 21 and 70.

- Alice Hertel, Jeen Broekstra et Heiner Stuckenschmidt : Rdf storage and retrieval systems. *In Handbook on Ontologies*, pages 489–508. Springer, 2009. Cited page 70.
- Pascal Hitzler, Markus Krotzsch et Sebastian Rudolph : *Foundations of semantic web technologies*. Chapman and Hall/CRC, 2011. Cited page 19.
- Narendra Jussien, Guillaume Rochart, Xavier Lorca *et al.* : Choco: an open source java constraint programming library. *In CPAIOR'08 Workshop on Open-Source Software for Integer and Constraint Programming (OSSICP'08)*, pages 1–10, 2008. Cited pages 49 and 94.
- Graham Klyne, Jeremy J Carroll et Brian McBride : Resource description framework (rdf): Concepts and abstract syntax. *W3C recommendation*, 10, 2004. Cited page 19.
- Mélanie König, Michel Leclère, Marie-Laure Mugnier et Michaël Thomazo : On the exploration of the query rewriting space with existential rules. *In International Conference on Web Reasoning and Rule Systems (RR-2013)*, pages 123–137, 2013. Cited page 66.
- Maurizio Lenzerini : Data integration: A theoretical perspective. *In 21st ACM SIGACT-SIGMOD-SIGART Symposium on Principles of Database Systems (PODS)*, pages 233–246, 2002. Cited page 8.
- Howard B. Newcombe, James M. Kennedy, S.J. Axford et A.P. James : *Automatic linkage of vital records*. 1959. Cited page 47.
- Ian Robinson, Jim Webber et Emil Eifrem : *Graph Databases*. O'Reilly Media, 2013. Cited pages 26, 38, and 41.
- Eric Salvat et Marie-Laure Mugnier : Sound and complete forward and backward chaining of graph rules. *In International Conference on Conceptual Structures (ICCS)*, pages 248–262, 1996. Cited page 17.
- Michael Schmidt, Thomas Hornung, Georg Lausen et Christoph Pinkel : Sp2bench: A sparql performance benchmark. *CoRR*, abs/0806.4627, 2008. Cited pages 82 and 90.

John F. Sowa : Conceptual graphs for a data base interface. *IBM Journal of Research and Development*, 20(4):336–357, 1976. Cited page 35.

Michaël Thomazo : Ontology based query answering with existential rules. *In Proceedings of the 23rd International Joint Conference on Artificial Intelligence (IJCAI-13)*, 2013. Cited pages 18 and 66.



List of Figures

1.1	Approaches for the OBDA problem.	2
3.1	Example: Scene cut from Tintin movie, featuring Tintin and the Duponts.	29
3.2	Relational database corresponding to the fact in the example.	33
3.3	Conceptual graph corresponding to the fact in the example.	36
3.4	Conceptual graph rule corresponding to the rule in the example.	37
3.5	Conceptual graph corresponding to the query in the example.	38
3.6	Property graph corresponding to the fact in the example.	40
3.7	Property graph corresponding to the query in the example.	41
3.8	Table comparing the features of the studied methods.	42
4.1	Class diagram representing the software architecture.	50
4.2	Listing of the K_1 and K_2 vocabularies.	60
4.3	Storing K_1 in the relational database.	62
4.4	Storing K_2 in the relational database.	63
4.5	Storing K_1 in a graph database using the Property Graph Model.	63
4.6	Storing K_2 in a graph database using the Property Graph Model.	64

5.1	Workflow for storing a knowledge base in RDF using ALASKA.	84
5.2	Storage time and KB sizes in different systems	87
5.3	Storage time and KB sizes in different systems	88
5.4	ALASKA storage and querying workflow.	89
5.5	Querying efficiency results for query 1.	90
5.6	Querying efficiency results for query 2.	91
5.7	Querying efficiency results for query 3.	91
5.8	Querying efficiency results for query 4.	92

Abstract

Ontology-Based Data Access is a problem aiming at answering conjunctive queries over facts enriched by ontological information. There are today two manners of encoding such ontological content: Description Logics and rule-based languages. The emergence of very large knowledge bases, often with unstructured information has provided an additional challenge to the problem. In this work, we will study the elementary operations needed in order to set up the storage and querying foundations of a rule-based reasoning system. The study of different storage solutions have led us to develop ALASKA, a generic and logic-based architecture regrouping different storage methods and enabling one to write reasoning programs generically. This thesis features the design and construction of such architecture, and the use of it in order to verify the efficiency of storage methods for the key operations for RBDA, storage on disk and entailment computing.

Keywords: *Ontology-Based Data Access, Knowledge Representation*

Résumé

Accès aux données en présence d'ontologies est un problème qui vise à répondre à des requêtes conjonctives en utilisant des inférences rendues possibles par une ontologie. Les deux grandes familles de langages utilisées pour coder une telle ontologie sont les logiques de description et les langages à base de règles. L'émergence de très grandes bases de connaissances, souvent peu structurées, complexifie aujourd'hui ce problème, d'autant plus que les données peuvent être stockées sous de nombreux formats. Nous avons ainsi développé ALASKA, une architecture logicielle générique dédiée à ce problème. ALASKA permet la manipulation (insertion, interrogation) des données indépendamment du système de stockage utilisé, et peut donc être vu comme la couche abstraite requise pour notre problème. Nous avons utilisé ALASKA pour tester l'efficacité de différents systèmes de stockages (bases de données relationnelles, bases de graphes, triple stores), que ce soit quant à la rapidité de l'insertion de nouvelles connaissances dans une base ou quant à l'efficacité des opérations élémentaires requises par les systèmes de requête.

Mots clefs : *Accès aux données en présence d'ontologies, Représentation de connaissances*
